



Refined Power and Signal  
from AC mains to  
Speakers!

2023

Luxuriously made products, elegantly engineered, sensuous sounding and looking, a pleasure to use, plus the finest parts, technology and materials treatment available today imparts that elusive sense of true quality all audio and video enthusiasts crave.

## Furutech's Pure Transmission Philosophy

Everything you see, hear, and experience from a home entertainment system depends entirely on the quality of the AC mains supply and the power supplies of each component. If you start with compromised power, you will never reach and experience those intimate moments of profound, nuanced, detailed and dynamic musical presentation, and audio and video enthusiasts quickly find the limits of so-called "industrial" or "hospital" grade AC power connections. At Furutech, we achieve precise signal transfer characteristics with meticulous, high-level engineering of the total product, focusing our energy on making the best, most luxurious, best sounding components using cutting-edge materials and processes. You will enjoy a greater sense of power, dynamics, and resolution, with cleaner, blacker backgrounds and a larger, more stable soundstage, with vivid tonal colors and deeper extension at both ends of the frequency range.

## NanoFlux Series Cables

*Refinement Has a New Name... Top End Performance Speaker Cable*



Furutech Alpha Nano-OCC is one of the best conductors Furutech engineers have found for sound reproduction. The new technology used in the highly specialized manufacturing process of this ultra-high performance power and signal cable combines Furutech's world renowned Alpha-OCC conductors with Furutech's extremely effective signal transmission enhancer, Nano Liquid. Nano Liquid's molecules are so tiny (8 nano-meters in diameter (8/1000000mm) they cover the Alpha-OCC surface and "fill up" any concave-convex sections left on the conductor surface during the production process, increasing the electric conduction area and debasing impedance. The results are extremely fine resolution down and through the very low noise floor, improved sound staging and image palpability, a musical, attractive, "round" midrange, tight and controlled bass, plus power and dynamics to spare to set your music on fire!

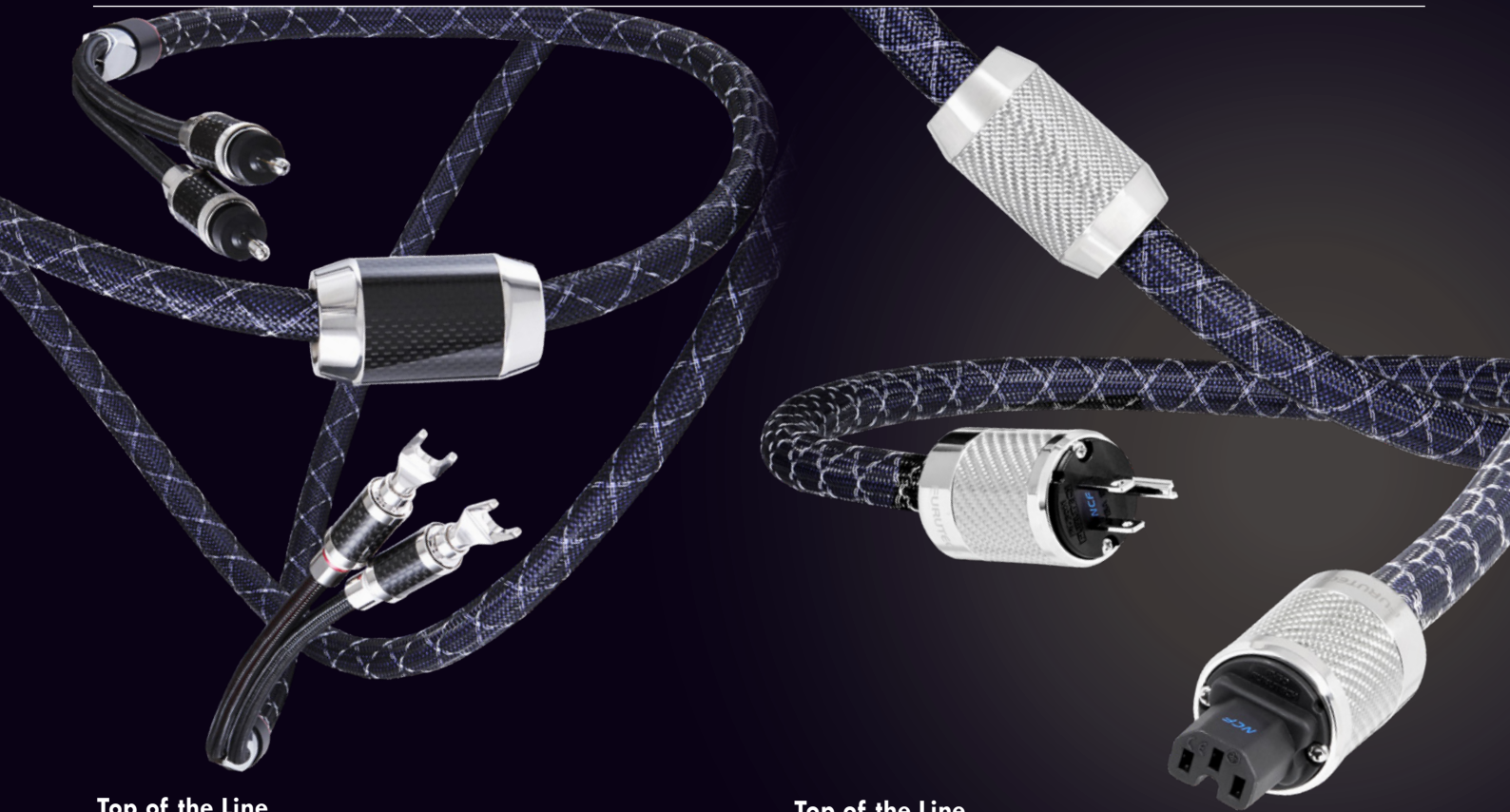

### Top of the Line

## NanoFlux Speaker Cable

Furutech specifies  $\alpha$  (Alpha) Nano-OCC Pure Transmission conductors terminated with high performance rhodium-plated nonmagnetic pure copper spade connectors for the amplifier end and rhodium-plated banana connectors at the other end. The smooth, natural, utterly musical presentation is down to meticulous engineering and careful audition of various suitable materials. These results in the superb overall balance of qualities that Furutech has long been known for that allows you to feel, experience and communicate with music.

- (Alpha) Nano-Au-Ag OCC Pure Transmission Conductors
- Filter: cotton
- Dielectric/insulation: Audio grade PE with resonance damping carbon powder
- Nonmagnetic rhodium-plated banana connectors CF-202R and spade connectors CF-201R NanoFlux Speaker Cable

### Top of the Line

## NanoFlux-NCF Power Cord

### La Grande Épreuve

Grand Prix racing's single focus: Testing the absolute limits of technology and performance. Furutech builds each and every cable in their line the same way. Optimized engineering solutions applied to advanced materials and processes with utterly meticulous build quality for the ultimate test.

- Fitted with Furutech's beautifully-finished FI-50 NCF(R) IEC and FI-50M NCF(R)/FI-E50 NCF(R) featuring  $\alpha$  (Alpha) Pure Copper conductors and the Floating Field Damper System (US Patent No.: 6,669,491 / European Patent No. EP1445837).
- The body of the connectors incorporates Furutech's unique and effective antiresonance and antistatic "NCF": Nano Crystal2 Formula - the ultimate electrical and mechanical damping material.
- Furutech's revolutionary Neo-Damper material incorporated into NCF connector housings.
- Nanoflux conductors are 3 x 3.8mm cores of  $\alpha$  (Alpha) Nano-OCC Conductors.
- Cable features a full  $\alpha$  (Alpha) conductor shield to protect against radiated noise.



Flux Cable Series -- Furutech  $\alpha$  (Alpha) OCC Pure Transmission conductors terminated with beautifully-engineered high-performance rhodium-plated connectors. The substantially-built extremely nonresonant connector bodies are finished in layered carbon fiber and nonmagnetic stainless steel providing improved mechanical damping for greater resolution, clarity, and powerful dynamics.

LineFlux-NCF (XLR)



## High End Performance NCF Interconnect LineFlux-NCF (XLR) & LineFlux-NCF (RCA)

- Furutech's new NCF RCA connector –CF-102 NCF & new NCF XLR connectors – CF-601M NCF/CF-602F NCF
- Solid core  $\alpha$  (Alpha) OCC Conductor.
- Double-layer shielding for improved noise insulation.
- Insulation/Dielectric: High-grade polyethylene
- Resonance damping material--Nano Ceramic and Carbon powder & PVC composite sheath.
- Dimensions: Cable diameter approx. 13.0mm.



## Fitted with Furutech's Award Winning FI-50 NCF Connectors PowerFlux- NCF Power Cord



- NCF series connectors feature  $\alpha$  (Alpha) Pure Copper conductors equipped with Furutech's advanced Floating Field Damper System (US Patent No.: 6,669,491/European Patent (EP1445837))
- Powerflux conductors are 7 bundles 68-strands 0.127mm diameter  $\alpha$  (Alpha) OCC conductor
- Cable features a full  $\alpha$  (Alpha) conductor shield to protect against radiated noise



## High End Performance Speaker Cable SpeakerFlux



- $\alpha$  (Alpha) OCC Pure Transmission Conductors (6 x 43/0.18mm+PE cord) x 2
- Nonmagnetic rhodium-plated banana connectors (CF-202) and spade connectors (CF-201R)
- Dielectric/insulation: High grade PE (white/red) Dia. 6.0mm



LineFlux-NCF (RCA)

Don't constrain your system at the speaker terminals!

## Speaker Jumper Cables JumperFlux



Furutech Speaker Jumper Cables use high-purity  $\alpha$  (Alpha) OCC conductor for minimal internal impedance. The Jumpers feature an insulation/ dielectric of high-grade PE that reduces capacitance and resonance.

Furutech Jumper cables results in greater resolution, clarity, more powerful dynamics, and an ultra-quiet soundstage in which music develops more coherently.

Jumperflux-S (spade)



Jumperflux-B (banana)



Jumper-S (spade)



Jumper-B (banana)



Srajan Ebaen of 6moons.com says:



## NCF Clear Line Series

"...once you've heard it then heard it taken away, you won't want to deny yourself if you can at all avoid it.."  
"...you won't be able to remain a tweak cynic when you hear this!"

NCF Clear Line series are audio grade passive AC optimizers, small enough to hold in your hand, that instantly enhances the quality of your power supply. Simply plug the NCF Clear Line into any vacant receptacle on either a power distributor or wall outlet and it only takes a moment to hear the improvement in the sound. You won't have to switch back and forth repeatedly in order to "discover" an improvement. It's right there. What you hear is the "NCF effect". The NCF Clear Line eliminates electrical and mechanical resonance from power flow with Furutech's NCF (anti-static and resonance damping material) and with the help of NCF Clear Line's Air Coils which damp and eliminate vibrations emanating from socket electrodes. You'll immediately notice improvements in the depth and focus of the sound stage, harmonics and tonal balance with NCF. Low frequencies are cleaner, with a greater sense of definition made possible by a lowered noise floor.



# High End Performance Connector & Cable Holder



## NCF Booster & NCF Booster-Signal & NCF Booster-Signal-L

Furutech Original Multi-Material Hybrid Construction ---For the Ultimate Connector and Cable Damping Solution Damping support for connectors at components or wall outlets and damping support for cables between components – boosting cable and connector performance.



### NCF Booster

- Multi-material hybrid construction – a Furutech original design.
- Support unit: audio-grade ABS resin and NCF nylon resin to eliminate static charge.
- Top clamp unit: stainless steel block and audio-grade NCF nylon resin.
- Base unit: audio-grade ABS resin body with slip-proof, shock-absorbing plate with counterweight.
- Height: Base level 80 mm / Extended level 140 mm approx.
- Overall dimensions: 94 x 99.7 mm approx.

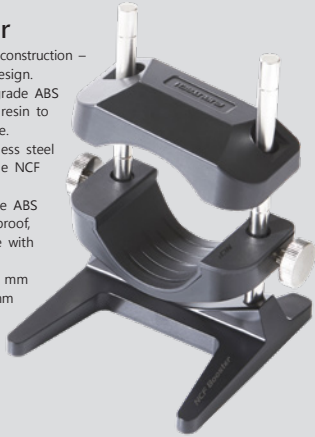

### NCF Booster-Signal

- Multi-material hybrid construction – a Furutech original design.
- Support unit: audio-grade ABS resin and NCF nylon resin to eliminate static charge.
- Base unit: audio-grade ABS resin body with slip-proof, shock-absorbing plate with counterweight.
- Height: Base level 82.5 mm/ Extended level 142 mm approx.
- Overall Base Unit Dimensions: 94.1 x 99.7mm approx.



### NCF Booster-Signal-L

- Multi-material hybrid construction – a Furutech original design.
- Support unit: audio-grade ABS resin and NCF nylon resin to eliminate static charge.
- Base unit: audio-grade ABS resin body with slip-proof, shock-absorbing plate with counterweight.
- Height: Base level 23.8 mm/ Extended level 81.4 mm approx.
- Overall Base Unit Dimensions: 89.8 x 66.0mm approx.
- Overall Dimensions: W46 x L106 x H23.8mm approx.



Furutech Original Multi-Material Hybrid Construction --- For the Ultimate Connector and Cable Damping Solution Damping support for connectors at components or wall outlets and damping support for cables between components – boosting cable and connector performance.

**NCF:** Nano Crystal<sup>2</sup> Formula Developed by Furutech, NCF features a special crystalline material that has two 'active' properties. First, it generates negative ions that eliminate static. Second, it converts thermal energy into far infrared. Furutech combines this remarkable material with nano-sized ceramic particles and carbon powder for their additional piezoelectric damping properties. The resulting Nano Crystal<sup>2</sup> Formula, exclusive to Furutech, is the ultimate electrical and mechanical damping material.



Audio Accessory magazine (Japan) top audio commentator Masamitsu Fukuda reports: ...First listening impression after setting the NCF Booster... Something has changed dramatically... muddiness gone... clarity! Increased sound to noise ratio, strengthened contrast and definition, response speed improved, transparency increased, and distortion reduced... improved space, depth and imaging. Very surprised by how much of an effect this product brings. Once set on your system, you won't want to remove it. A completely new audio accessory has arrived. Masamitsu Fukuda Audio Accessory (Japan)

Multi award-winning NCF Booster series of connector and cable holders featuring Furutech's revolutionary damping material, NCF (Nano Crystal<sup>2</sup> Formula). Designed and developed by Furutech, the NCF Booster series of products provide the ultimate connector and cable damping solution. They elevate power cables and support power connectors, allowing optimum alignment between connector and socket at both component and wall outlet ends. At the same time, they cleverly boost cable and connector performance by damping mechanical and electrical vibrations and eliminating static charge, thanks to Furutech's proprietary NCF (Nano Crystal<sup>2</sup> Formula).

The NCF Booster series of products will take your system to the next level, enhancing clarity and resolution and delivering a more defined soundstage - all for the finest Furutech Pure Transmission signal imaginable.

Optional parts:



Top clamp

Extension shafts (10pcs)

Cradle (flat)

Cradle (curved)

Shaft Bar Adjusters

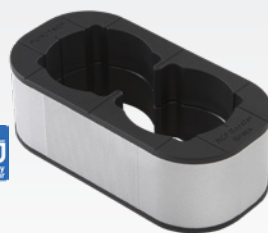

### Introducing new

### NCF Booster-Brace and NCF Booster-Brace-Single

Designed for supporting and boosting performance of power connectors at wall sockets and on power distributors

- NCF (multi-material hybrid structure): NCF formulated nylon resin (Body).
- Anti-vibration grooves: suppresses surface vibration.
- Housing: Special blasted and anodized aluminum alloy.
- Vibration suppression walls and pressurized chambers (NCF damping wall) for elimination of resonance.
- NCF Booster-Brace: Overall Dimensions: W 54 X L 106 X H 35mm approx. Net Weight: 100g approx.
- NCF Booster-Brace-Single: Overall Dimensions: W 54.3 X L 64.8 X H 38.5mm approx. Net Weight: 67.5g approx.

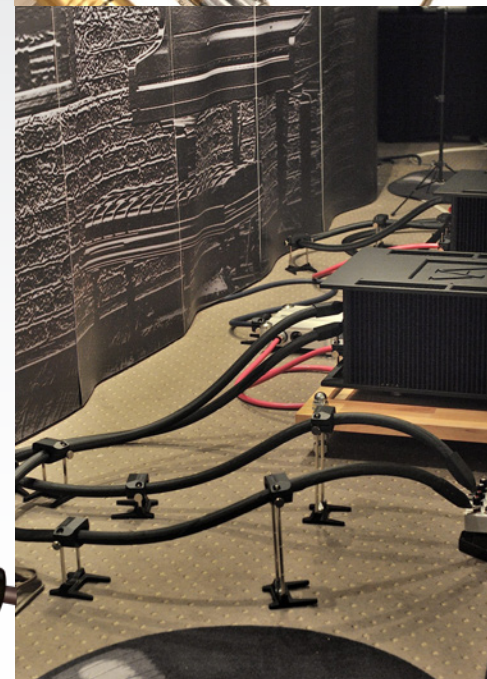
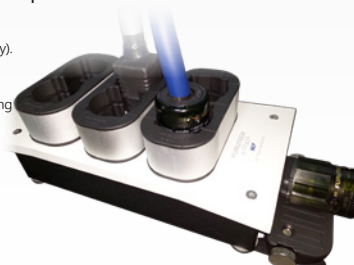



# Furutech Inline Power Filters AC Power Can Make or Break Your System!

The audio you hear from your home entertainment system is essentially the incoming electricity itself, and the typically violent storms riding the AC line and its ground is very detrimental to the performance of your components. Furutech Inline Filters eliminate many common problems caused by contaminated electrical power lines. They protect against distortion caused by ground noise, voltage spikes and sags, high frequency power supply noise from other components in your own system, and finally high-frequency digital noise emanating from processors and digital interconnects.

And while the Furutech Inline filters are star performer at eliminating common AC problems, they do it all without restricting current draw in any way.

The Flow-28, Flow-15 Plus & Flow-08 are star performers at eliminating common AC problems, they do it all without restricting current draw in any way. A AC-1501 EMI-filtering IEC input effectively eliminates distortion.



## Flow-28 Flow-15 Plus Flow-08



- For connection between power cables and power distributors or power cables and components. Eliminate and prevent radiated AC noise
- Floating Field Damper (Earth/Ground Jumper System) (US Patent No.: 6,669,491/European Patent (EP1445837))
- Patent-pending metal cable clamp improves grip and reduces mechanically and electrically induced distortion
- $\alpha$  (Alpha) conductor shield for protection against radiated noise
- Special high-grade PE Insulation contributes to reduced capacitance
- Filter held in housing with resonance damping Piezo epoxy

# Furutech Inline Power Filters Lower Noise in Mixed Digital and Analog Systems

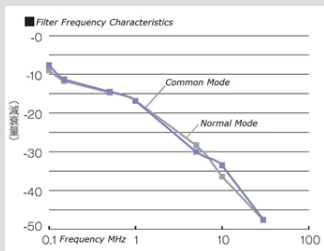
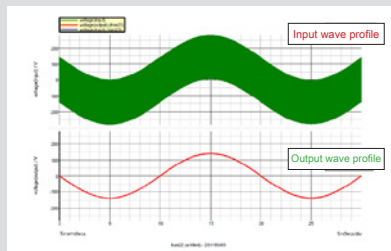

Fig.1 illustrates the Flux-50's common-mode noise blocking filtering effect.



Increasing time and voltage in the graph below reveals the 100V/10MHz noise in the input wave profile.

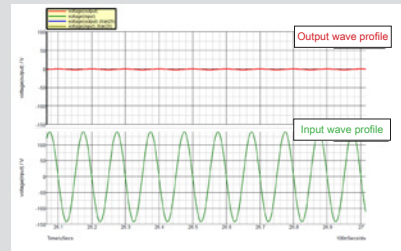

Fig.2 illustrates the results. Input AC 100V/10MHz noise wave profile is superimposed over AC 100V/50MHz wave profile simulating high frequency noise cutoff effect.

**Results**

- High frequency noise (green) is substantially suppressed
- Noise suppression is effective for common-mode and normal modes so effectiveness enhanced for systems mixing digital and analog components

## Furutech Studio Series Power Cords

The new Furutech Astoria and Empire power cords were designed for demanding professionals. Developed in Tokyo with extensive feedback from musicians and recording professionals, the Astoria and Empire power cords have been specifically tuned and balanced to deliver greater punch and dynamics to your sound. Pick the Astoria if you're aiming for quick response and natural speed, mated with deep and powerful bass. The Empire, on the other hand, offers a well-balanced sound with incredible resolution so that you hear every detail and nuance.

### The Empire



Fitted with Gold-plated Furutech FI-11M (G) or FI-E11 (G) and FI-11 (G) IEC connector (1.5m)

- Conductors: 45-strand PC Triple C 0.32mm x 3 cores
- Insulation: Audio grade Flexible PVC (Brown, Light Blue, Green with Yellow striping) OD: 5.0mm diameter approx.
- Inner Sheath: Audio grade Flexible PVC (Black)
- Shielding: 0.12mm OFC Wire Braid
- Sheath: RoHS-compliant Audio grade flexible PVC (Dark Green), 16.0mm diameter approx.



### The Astoria



Fitted with Non-plated Furutech FI-11M (Cu) or FI-E11 (Cu) and FI-11 (Cu) IEC connector (1.5m)

- Conductors: 80-strand PC Triple C 0.18mm x 3 cores
- Insulation: Audio grade Flexible PVC (Brown, Light Blue, Green with Yellow striping) OD: 3.5mm diameter approx.
- Inner Sheath: Audio grade Flexible PVC (Black)
- Shielding: 0.12mm OFC Wire Braid
- Sheath: RoHS-compliant Audio grade flexible PVC (Dark Green), 12.8mm diameter approx.



### Absolute Power-15Plus



1.5 meter (4.9ft)

- 56 inner and 29 outer strands · 0.175mm diameter  $\alpha$  (Alpha) -OCC x 3 core, 1.9mm diameter
- Sheath (Inner): RoHS Compliant Vibration Suppression PVC (Black) 9.5mm diameter
- Shield: 9 x 24 0.12mm copper wire stranded braid
- Sheath (Outer): RoHS Compliant Flexible PVC (Dark Blue) 14.2mm diameter
- Connectors: FI-15-Plus(R) IEC and FI-15M-Plus(R)
- Europe version: FI-15-Plus(R) and FI-E11(R) schuko connector



### G-31 4Ag-15Plus



1.5 meter (4.9ft)

- Red: 37 strand silver-plated  $\alpha$  (Alpha)  $\mu$ -OFC Conductor 0.25mm diameter
- White: 37 strand silver-plated  $\alpha$  (Alpha)  $\mu$ -OFC Conductor 0.25mm diameter
- Green: 37 strand  $\alpha$  (Alpha)  $\mu$ -OFC Conductor 0.25mm diameter
- Inner Sheath: RoHS Compliant Vibration Suppression PVC (Black) 9.3mm diameter
- Shield: 9 x 24-strand 0.12mm braided  $\alpha$  (Alpha) Conductor
- Sheath: RoHS Compliant Flexible PVC (Brown) approx. 12.9mm diameter
- Connectors: FI-15-Plus(G) IEC and FI-15M-Plus(G) Power Connector
- Europe version: FI-15-Plus(G) and FI-E11(G) schuko connector



## Furutech Slimline Series Power Cords

The new Furutech Slimline power cords were designed for discerning listeners and home theater enthusiasts with an eye for detail. Developed in Tokyo with extensive feedback from top Japanese audio and video commentators, the Odeon and Roxy power cords have been specifically tuned to deliver greater depth, extension and dynamics to your playback experience.

### The Odeon



The Odeon Power Cord delivers blacker blacks and more vivid colors and gives sound greater resolution, clarity, and dynamics in an ultra-quiet soundstage where the sound blooms seamlessly from top to bottom without artificial upper-frequency "presence region" glare. The new slimline IEC connector also allows for easy connection to space restricted IEC sockets that can be found on some high-end projectors and HD screens.

- Fitted with a Non-plated Furutech FI-15ME(Cu) AC connector and a FI-C15(Cu) IEC connector. EU version: The Odeon-E is fitted with a non-plated FI-E11(G) schuko connector and FI-C15(Cu) IEC connector
- Silver-plated  $\alpha$  (Alpha)  $\mu$ -OFC Conductors
- RoHS-compliant audio grade flexible PVC sheath improves vibration isolation
- Special audio grade polyethylene Insulation contributes to reduced capacitance



### The Roxy



The Roxy Power Cord has been designed and tuned to complement a wide range of analog components. It delivers a balanced energy allowing for a powerful, yet stable and defined bass. Greater extension at both low and high frequencies delivers clear and dynamic imagery in an ultra-quiet soundstage. The new slimline IEC connector also allows for easy connection to light weight components, like phono stages and is perfect for fitting space restricted IEC sockets that can be found on some high-end components.

- Fitted with a gold-plated Furutech FI-11M(G) AC connector and a FI-C15(G) IEC connector. EU version: The Roxy-E is fitted with a gold-plated FI-E11(G) schuko connector and FI-C15(G) IEC connector
- Silver-plated  $\alpha$  (Alpha)  $\mu$ -OFC Conductors
- RoHS-compliant audio grade flexible PVC sheath improves vibration isolation
- Special audio grade polyethylene Insulation contributes to reduced capacitance



# Furutech Analog Accessories

The Silver Arrows-II Pure Silver Phono Cable achieves its remarkably quiet soundstage and elegant, nuanced sound with  $\alpha$  (Alpha) Silver Hybrid OCC Conductors, three-layer shielding and external ground wire, even a specially engineered Neo Dampener cable splitter eliminating any distortion whatsoever. The Silver Arrows-II Pure Silver conductors are terminated with beautifully engineered high-performance rhodium-plated nonmagnetic  $\alpha$  (Alpha) OCC RCA connectors and with connector bodies finished in layered carbon fiber. Available in three combinations: straight DIN to RCA. Angled DIN to RCA and RCA to RCA



## The Silver Arrows-II

### Silver Hybrid OCC Conductor Phono Cable



- $\alpha$  (Alpha) Silver Hybrid OCC Conductors
- Four-way grounding and external ground wire
- Insulation/Dielectric: Audio grade SR-PVC and Nitrogen injected skin-foam-skin polyethylene
- Connectors: Furutech-engineered rhodium-plated Carbon and Stainless finished CF-DIN connector or L-DIN connector and CF-102(R) $\alpha$  (Alpha) OCC RCA connectors or CF-601M XLR connectors (by request)
- Carefully engineered cable splitter features Neo Dampener (an extremely effective elastomer composite for vibration damping in sensitive electrical and mechanical devices) - reducing mechanical and electrically-induced distortion
- Dimensions: Cable diameter approx. 10.0 mm • Overall length: 1.2M/set

- Three-layer shielding for improved noise insulation



The Ag-16 Phono Cable achieves its natural transparent presentation with silver-plated  $\alpha$  OCC conductors, three-layer shielding and external ground wire, even a specially engineered cable clamp to improve grip and avoid any potential distortion.

## Ag-16 Pure Transmission Silver-Plated Phono Cable



- Silver-plated  $\alpha$  (Alpha) OCC Conductors
- Three-layer shielding for improved noise insulation
- Four-way grounding and external ground wire
- Insulation/Dielectric: Special-grade nitrogen injected skin-foam-skin polyethylene
- Connectors: Furutech-engineered rhodium-plated Carbon and Stainless finished CF-DIN connector or L-DIN connector and CF-126(R)  $\alpha$  (Alpha) OCC RCA connectors or CF-601M XLR connectors. (by request)
- Carefully engineered cable clamp improves grip and reduces mechanical and electrically-induced distortion
- Dimensions: Cable diameter approx. 8.0 mm • Overall length: 1.1M/set

The sense of mechanical integrity of the Ag-12 Tonearm cable's build is immediately apparent. Furutech Pure Transmission technology turns a macro lens on every element of power and signal transfer applying optimized engineering solutions to well-known problems such as contact resistance, grounding, EMI and RFI rejection, and using the best materials and processes available. Available in three combinations: straight DIN to RCA. RCA to RCA and DIN to XLR.

## Ag-12 Pure Transmission Silver-Plated Phono Cable



*The award for best performance and highest build quality at the lowest price goes to the Furutech AG-12." -- Michael Fremer, Stereophile July 2009 Vol.32 No.7*

- $\alpha$  (Alpha) silver-plated  $\mu$ -OFC Conductor
- 4-layer shield construction for improved noise insulation
- Connectors: Furutech-engineered rhodium-plated DIN or L-DIN and FP-126(R) Alpha-OCC RCA connectors • The best damping and insulation materials for improved frequency extension and tonal balance
- Carefully engineered cable clamp improves grip and reduces mechanical and electrically-induced distortion
- Dimensions: Cable diameter ---9.5mm • Overall length: 1.2M/set

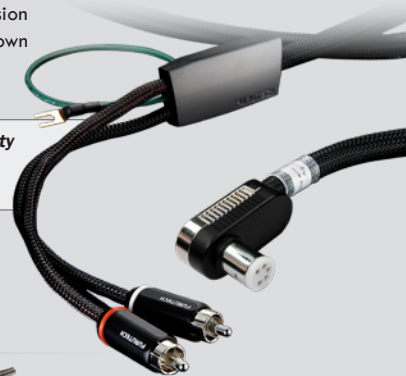

Monza



Monaco



La Source 103



La Source 101



## Monza & Monaco LP Stabilizer

Furutech employs nano-sized polycrystalline ferroelectric ceramic particles exhibiting electro generative properties and combines them with carbon powder that has thermal-conductive characteristics. These materials in the Monza and Monaco stabilizers convert electrical and mechanical oscillation energy into heat that is then conducted away and released from the surface of the Monza and Monaco, all the while providing the perfect weighted surface for your LPs. That's how far Furutech goes to achieve Pure Transmission LP playback. Weight: Monza 350  $\pm$  5g; Monaco 210  $\pm$  5g



## La Source 103 Headshell Leads

La Source 103 Headshell Leads are Furutech's latest introduction to their award winning analog accessory range. With Silver-plated  $\alpha$  (Alpha) OCC conductors and specially engineered four-point terminals for improved grip and elimination of mechanical distortion, these high-end leads offer remarkable cost performance.

## La Source 101 Long Headshell Leads

La Source Long Silver Headshell Leads achieve their remarkably quiet soundstage and transparent presentation with pure silver conductors and a specially engineered four-point terminal for improved grip and elimination of mechanical distortion.

## Introducing the DeMag $\alpha$



The new and improved Furutech DeMag $\alpha$  completely demagnetizes LPs and optical disc media such as CD, CD-R, DVD, MD, Game CD, Photo CD, SACD, and DVD Audio with 20% increased demagnetization power than the original DeMag. Plus it's an indispensable accessory for keeping interconnect cables, connectors and power cords demagnetized to prevent magnetic signal distortion.

- Net Weight: 14.0Kgs/30.5lbs
- Rating: 110VAC  $\pm$  15V (USA)
- Rating: 230VAC  $\pm$  10V (Europe)

Licensed by Sekiguchi Machine Sales Ltd

*"... demagnetizing an LP definitively removed a high frequency glaze or glare and seemed to enrich the midband... Demagnetizing LPs works. And do not try one of these devices unless you're prepared to buy it."*  
 -- Michael Fremer, Stereophile



# Exceptionals



## destat III

Improved destat III Removes Dust and Static for Ultimately Refined Sound Zap!

The destat III is incredibly easy to use and removes dust and static charge from audio/video media with a few seconds. High performance enthusiasts know that static charges on analog and optical media – LPs, CDs and DVDs – can lead to sudden and distracting noise that compromises the experience. Simply place your media on or hold it under the destat III and press one button! The powerful fan removes dust while the destat III's improved Ion Flow Generator –featuring 4 emitters that simultaneously generate static-eliminating ions. Requires 4 AA Batteries (Included)

## PC α Pure Cleaner



Keeps CDs, DVDs and video/PC/Smartphone screens clean and free of static charge

Based on combination of enzymes and ions, this pure, natural product has a powerful cleansing action on any CD or DVD. It maximizes the laser's ability to read the data producing a very high level of resolution. PCα is totally free of pollution-causing materials including active agents and chemical skin irritants. PCα is environmental friendly and extremely safe to use.

Even with its powerful cleaning action, PCα is harmless to most surfaces. Because there are no oily additives, it leaves no residual trace, the treated surface is sparkling clean and ready for a life of zero-failure reads.

## High End Performance

## NANO Liquid Contact Enhancer



Revives old connections and improves new connections

Incredible Nano Liquid's molecules are so tiny (8 nano-meters in diameter (8/1000000mm) they "fill up" any air bubble holes left during the plating process when brushed onto connectors. The result is much better contact between metal surfaces. Nano Liquid is a result of Furutech's Total Attention to Detail regarding every aspect of signal transmission. Use only a little!

# Audio / Video / Digital Cable

"The LAN-8 NCF's have been brilliant here, bringing a definite step forward in our reference streaming/music server applications. The level of transparency and detail continues to move forward (does it ever end?!), especially with the quality of the associated electronics with designs from companies like T+A, Aurender, and exaSound. Extremely impressive!"

Dr. David W Robinson,  
Editor-in-Chief,  
Positive Feedback

## High End Performance Ethernet Cable Category 8 (8P8C S/FTP)

### LAN-8 NCF

Ultra-high-speed transmission cable with speeds up to 40Gbps 2000MHz 24AWG S/FTP with triple shielding, deep 24k gold plated RJ45 connector and NCF shell

The LAN-8 NCF is a beautifully engineered and built Category 8 S/FTP twisted pair cable for Ethernet and other high-speed signal transfer. NCF Connector Shell Multi-material hybrid construction. NCF features a special crystalline material that has two 'active' properties. First, it generates negative ions that eliminate static. Second, it converts thermal energy into far infrared. Furutech combines this remarkable material with nano-sized ceramic particles and carbon powder for their additional 'piezoelectric effect' damping properties. The resulting Nano Crystal Formula is the ultimate electrical and mechanical damping material. Created by Furutech, it is found exclusively in Furutech products. NCF delivers improvements in the depth and focus of the sound stage, harmonics and tonal balance with NCF. Low frequencies are cleaner, with a greater sense of definition made possible by a lowered noise floor.

- Category 8 cable allows 40 Gigabit Ethernet and frequencies of up to 2000 MHz (Category 7 X 3.3). Noise interference resistant, providing a fast and stable network environment.
- Main conductor wire: 24 AWG (19/0.12) Silver plated α (Alpha) OCC conductor for minimal transmission loss.
- Jacket: UL/CL3 approved flammability grade; RoHS Compliant Flexible PVC (Black) and high-quality nylon yarn braided sleeve single effect preventing internal resonance and exhibiting improved damping performance. OD: 7.0 0.1mm approx.
- Production Lengths: 0.6M/1.2M/1.8M/2.5M/3.6M/5M and 7.5M/10M by request.

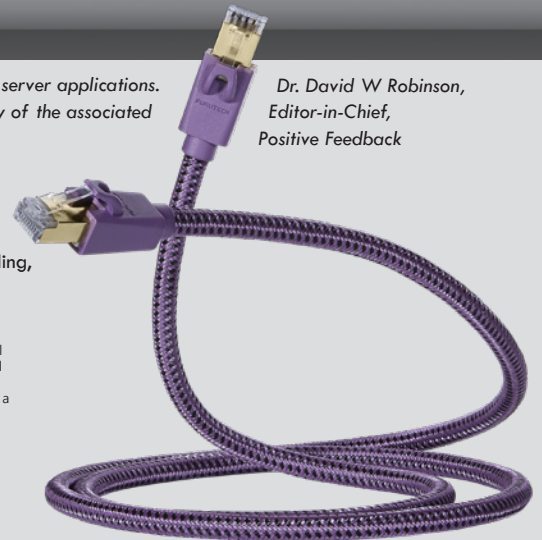

Furutech introduces two of the highest specified HDMI cables available anywhere. Incorporating Furutech's unique and effective resonance and static eliminating material NCF. The HF-X-NCF & HF-A-NCF HDMI cables will take your listening and viewing experience to the next level.

## Ultra-high speed silver-plated μ-OFC HDMI Cable HF-X-NCF

Ultra-high speed 8K/60p/48Gbps transmission

- HF-X-NCF features a connector shell incorporating Furutech's proprietary electrical and mechanical damping material, NCF.
- 26 AWG silver-plated μ-OFC main conductor designed to improve conductivity and ensure stable transmission.
- Double layer aluminium foil shielding for each twisted conductor, plus a third copper braiding layer, to prevent static, EMI, FFI and RFI, eliminating noise and crosstalk.
- Production lengths: 1.2m (3.9ft); 2.5m (8.2ft); 3.6m (12ft); 5m (16ft)

## Ultra-high speed HDMI Active Optical Cable (AOC) HF-A-NCF

Ultra-high speed 8K/60p/48Gbps transmission

- HF-A-NCF's cable clamp incorporates Furutech's proprietary electrical and mechanical damping material, NCF.
- Four OM3 multi-mode optical fibers.
- Special photoelectric conversion circuitry to deliver the ultimate in balanced signal amplification.
- Production lengths: 1.5m (4.9ft), 3m (9.8ft), 5m (16.4ft), 7.5m (24.6ft), 10m (32.8ft), 15m (49.2ft), 20m (65.6ft)



Following on from the success of the Furutech GT2 USB cable Furutech now introduces the higher specified GT2Pro 2.0 USB cable. The cable is formed around special α (Alpha) OCC silver copper hybrid conductors with superior high-density polyethylene insulation/dielectric. The GT2Pro features three-layer shielding and specially engineered 24k gold-plated USB 2.0 connectors

with a special 24k gold-plated copper alloy EMI shield incorporated into the connector. The cable wrap includes damping and insulating materials keeping mechanical ringing from affecting the sound. A carefully engineered clamp improves grip and keeps both mechanical and electrical distortion at bay. The GT2Pro series creates real musical experience from the data stored on your computer.

## GT2Pro USB Cable



- Main conductor: 26AWG α (Alpha) OCC Silver Copper hybrid Conductors
- Power conductor: 24AWG Silver-plated α (Alpha) OCC Conductors
- Main Insulation: Special-grade high-density polyethylene
- 3-layer shield construction for improved noise insulation
- Connectors: Furutech-engineered 24k gold-plated USB series Connectors with a special 24k gold-plated copper alloy EMI shield incorporated into the connector
- The best damping and insulation materials for improved frequency extension and tonal balance
- GT2Pro-B (Type A to B) and GT2Pro -mini B (Type A to mini-B) Lengths :
- Cable Lengths: 0.3m (1ft) / 0.6m (2ft) / 1.2m (4ft) / 1.8M (6ft) / 3.6m (12ft) / 5.0m (16.5ft)

## GT2 USB Cable



- Main conductor: Silver-plated α (Alpha) OCC Conductors
- 3-layer shield construction for improved noise insulation
- Connectors: Furutech-engineered 24k gold-plated USB series Connectors
- Cable Types: USB-B (Type A-B)
- Cable Lengths: USB-B (Type A-B) / 1.2m (4ft) / 1.8M (6ft) / 5.0m (16.5ft)



# High End Performance Reference III Series Cables

*"...If you are an audiophile and music lover who subscribes to the philosophy that the components in your system should be as accurate and neutral as possible, and that the cables' main job is to be an undistorted conduit, then the Furutech Reference III cables should be at the top of your list..."*

— Jeff Dorgay, Tone Audio 2009



Double-shielded  $\alpha$  (Alpha)-OCC conductor interconnects, power cords and digital cables featuring extraordinary build quality and Formula GC-303 antimagnetic EMI-absorbent modules surrounding the cable offering greater resolution, more powerful dynamics, and virtuoso performances from all your components.



## High End Performance Interconnect Audio Reference III RCA 1.2 meter (3.9ft)

- 30-strand  $\alpha$  (Alpha)- OCC Conductor · 0.18mm , 1.14mm diameter
- Insulation: 30% air-foamed HDPE(Red/White) 2.60mm diameter
- Shield-1: 0.12mm braided  $\alpha$  (Alpha) Conductor braid density: 80% UP / 6.3mm diameter
- Shield-2: Special EMI- and noise-absorbent Formula GC-303 module
- Connectors: FP-106(R) RCA



## High End Performance Interconnect Audio Reference III XLR 1.2meter (3.9ft)

- 30-strand  $\alpha$  (Alpha)- OCC Conductor · 0.18mm , 1.14mm diameter
- Insulation: 30% air-foamed HDPE (Red/White) 2.60mm diameter
- Shield-1: 0.12mm braided  $\alpha$  (Alpha) Conductor braid density: 80% UP / 6.3mm diameter
- Sheath: RoHS Compliant flexible PVC (Dark Brown) 8.0mm diameter
- Shield-2: Special fiberglass and copper wire stranded braid
- Shield-3: Special EMI- and noise-absorbent Formula GC-303 module
- Connectors: FP-603 M(R) and FP-604 F(R) XLR



## High End Performance Power Cables Power Reference III 1.8 meter (5.9ft)

- 49-strand  $\alpha$  (Alpha)-OCC · 0.32mm x 3 cores, 2.5mm diameter
- Insulation: Irradiated PE (Red/Natural/Yellow) 5mm diameter
- Inner Sheath: RoHS Compliant Vibration Suppression PVC (Black) 12mm diameter
- Outer Sheath: RoHS Compliant flexible PVC (Dark Green) 15mm diameter
- Shield: Special EMI- and noise-absorbent Formula GC-303 module
- Upgrade the body to FI-28(R) IEC and FI-28M(R)
- Europe version: FI-28(R) IEC and FI-E35(R) schuko connector



## High End Performance Speaker Cable Speaker Reference III-04 2 meter (6.5ft) Speaker Reference III-06 3 meter (9.8ft)

- 6 bundles of 20-strand  $\alpha$  (Alpha)- OCC Conductor-0.16mm, 2.7mm diameter
- Insulation: Air-foamed Irradiated PE (Red/White) 5.1mm diameter
- Cable Lay: Two cores twisted together
- Sheath: RoHS Compliant flexible PVC (Purple/Red) 13mm diameter
- Shield: Special EMI- and noise-absorbent Formula GC-303 module
- Jacket: Nylon yarn braid approx. 14.5mm
- Connectors: FP-201(R) spade terminal or FP-202(R) Bananas by request



## High End Performance Digital Datalink Digital Reference III XLR / RCA 1.2 meter (3.9ft)

- XLR Specifications:
- 30-strand  $\alpha$  (Alpha)- OCC Conductor · 0.18mm , 1.14mm diameter
  - Insulation: 30% air-foamed HDPE (Red/White) 2.60mm diameter
- RCA/BNC Specifications:
- 37-strand  $\alpha$  (Alpha)- OCC Conductor · 0.16mm, 1.15mm diameter
  - Insulation-1:HDPE 1.75mm diameter
  - Insulation-2: Air-formed PE, 5.5mm diameter

### Common Specifications:

- Shield-1: 0.12mm braided  $\alpha$  (Alpha) Conductor braid density: 80% UP x 6.3mm diameter
- Sheath: RoHS Compliant flexible PVC (Dark Brown) 8.0mm diameter
- Shield-2: Special fiberglass and copper wire stranded braid
- Shield-3: Special EMI- and noise-absorbent Formula GC-303 module
- Connectors: FP-603 M(R) and FP-604 F(R) XLR or FP-106(R) RCA or FP-3-117(R) BNC



## High End Performance Speaker Cable Bi-Wire Speaker Reference III-04 2 meter (6.5ft) Bi-Wire Speaker Reference III-06 3 meter (9.8ft)

- Shielded  $\alpha$  (Alpha)-OCC Conductors eliminate radiated noise: 6 bundles of 25-strand  $\alpha$  (Alpha)-OCC Conductor-0.16mm for Treble, 6 bundles of 41-strand  $\alpha$  (Alpha)-OCC Conductor · 0.16mm for Bass

- High performance beautifully engineered and finished with nonmagnetic Rhodium-Plated pure copper spades
- Results in greater resolution, clarity, powerful dynamics, and an ultra-quiet soundstage in which music develops more fully without artificial upper-frequency "presence region" glare.
- Formula GC-303 Antimagnetic EMI-Absorbent Modules surround each cable allowing a deeper, tighter bass to form a solid foundation for the rest of the frequency range, better defining the original recordings venue. Natural, unforced detail reveals nuance and energy for an engaging musical experience.
- Connectors: FP-201(R) spade terminal or FP-202(R) Bananas by request

# Evolution II Series Cables

*"...Furutech's cables offer great transparency and purity, plus an uncanny ability to block out noise and grunge..."*

— Chris Martens The Absolute Sound Editors' Choice Awards 2007



## High Performance Audio Interconnect Evolution Audio II RCA 1.2meter (3.9ft)

- 80-strand  $\alpha$  (Alpha) -OCC Conductor · 0.18mm, 1.86mm diameter
- Insulation: Polypropylene (Red, White) 2.46mm diameter
- Cable Lay: Two cores twisted together with cotton yarn
- Cable Wrap: Non-woven fabric wrap approx.5.0mm
- Shield: 0.12mm braided  $\alpha$  (Alpha) Conductor 6.3mm diameter
- Sheath: RoHS Compliant Flexible PVC (Dark Green) 9.0mm diameter
- Jacket: Nylon yarn braid approx. 10mm
- Connectors: FP-110(G) RCA



## High Performance Audio Interconnect Evolution Audio II XLR 1.2meter (3.9ft)

- 80-strand  $\alpha$  (Alpha) -OCC Conductor · 0.18mm, 1.86mm diameter
- Insulation: Polypropylene (Red/White) 2.46mm diameter
- Cable Lay: Two cores twisted together with cotton yarn
- Cable Wrap: Non-woven fabric wrap approx. 5.0mm
- Shield: 0.12mm braided  $\alpha$  (Alpha) Conductor approx. 6mm diameter
- Sheath: RoHS Compliant Flexible PVC (Dark Green) 9.0mm diameter
- Jacket: Nylon yarn braid approx. 10mm
- Connectors: FP-701 M(G) and FP-702 F(G) XLR



## High Performance Audio Digital Cable Evolution Digital II XLR 1.2meter (3.9ft)

- $\alpha$  (Alpha)  $\mu$ -OFC Conductor 1.3mm diameter
- Insulation: Polypropylene (White/Red) 2.4mm diameter
- Shield: 0.12mm  $\alpha$  (Alpha) Conductor wire braid
- Sheath: RoHS Compliant flexible PVC (Dark Green) 8mm diameter
- Jacket: Nylon yarn braid approx. 9.5mm
- Connectors: FP-701 M(G) and FP-702 F(G) XLR



## High Performance Digital Cable Evolution Digital II RCA 1.2meter (3.9ft)

- 37-strand  $\alpha$  (Alpha) -OCC Conductor · 0.16mm, 1.15mm diameter
- Insulation-1: HDPE 1.75mm diameter
- Insulation-2: Air-foamed PE 5.5mm diameter
- Shield-2: 0.12mm braided  $\alpha$  (Alpha) Conductor ,63mm diameter
- Sheath: RoHS Compliant flexible PVC (Dark Blue) 8mm diameter
- Jacket: Nylon yarn braid approx. 9.5mm
- Connectors: FP-110(G) RCA or FP-3-117(R) BNC.



## High Performance Audio Speaker Cable Evolution Speaker II-04 2 meter (6.5ft) Evolution Speaker II-06 3 meter (9.8ft)

- 6 bundles 20-strand  $\alpha$  (Alpha) $\mu$ -OFC Conductor · 0.18mm, 2.81mm diameter
- Insulation: Special polyethylene (Red/White) 5.1mm diameter
- Cable Lay: Two cores twisted together with cotton yarn
- Sheath: RoHS Compliant flexible PVC (Dark Green) 13.5mm diameter
- Jacket: Nylon yarn braid approx. 14.5mm
- Connectors: FP-203(G) spade or FP-202(G) Banana

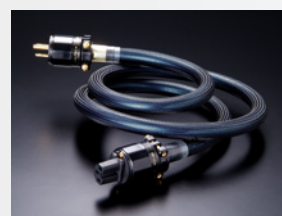

## High Performance Audio Power Cable Evolution Power II 1.8 meter (5.9ft)

- 7 bundles 35-strand  $\alpha$  (Alpha) $\mu$ -OFC Conductor · 0.18mm x 3 cores, 3.69mm diameter
- Insulation: Polyethylene (Red/Natural/Yellow) 5.5mm diameter
- Sheath (Inner): RoHS Compliant Vibration Suppression PVC(Black) 13.5mm diameter
- Shield: 9 x 24-strand 0.12mm copper stranded wire braid
- Sheath: RoHS Compliant Flexible PVC (Pearl Blue) Diameter: 17.5mm
- Jacket: Nylon yarn braid approx. 18.5mm
- Connectors: alpha pure copper conductor FI-11(R) IEC Connector and FI-11M(R) Power Connector
- Europe version: FI-11(R) IEC Connector and FI-E11(R) Schuko Connector



Top-of-the-Line Furutech Power Distributor

**PURE POWER 6 NCF**



Furutech have upgraded their Pure Power 6 AC Mains Distributor, the ultimate expression of Furutech's Pure Transmission Technology. Furutech engineers each and every step of power and signal transfer--no matter how small--using the finest materials and technologies available, like their sockets and outlets, Formula GC-303 EMI-absorbent material and Two-Stage Cryogenic and Demagnetizing Super α (Alpha) Treatment applied to all metal parts.

**Luxury Build**

The Pure Power 6 NCF is built like a Swiss bank vault, a virtual black hole for EMI and RFI. The substantial, beautifully-crafted chassis is precision CNC-machined from solid aerospace-grade aluminum alloy that effectively shields against RFI (Radio Frequency Interference). Three separate milled compartments house three independently-wired duplex receptacles using top-quality Alpha OCC conductor UL compliant Special grade Flexible PVC Insulated wire α(Alpha)-12. The hot and neutral conductor bundles from the FI-09 NCF IEC inlet are loomed into a large, centrally-located chamber--secured Bugatti-like with eight beautifully machined rivets.



**Specifications:**

- Chassis: CNC machined aerospace-grade aluminum alloy
- Ground/Earth connection: Chassis Grounding Post
- IEC Inlet: FI-09 NCF (R)- α pure copper conductor rhodium-plated
- 3 High End Performance GTX-D NCF (R) Duplex Receptacles or 6 High End Performance FI-E30 NCF schuko sockets
- Internal wiring: high quality Alpha OCC conductor wire α (Alpha)-12 (14AWG/3.38 Sq.mm)
- Size: 8"/250mm W x 8"/250mm H x 3"/95mm D
- Weight: 22lbs/10kgs (Schuko model: Pure Power 6-E NCF)

**FURUTECH'S**

Patented Axial Locking System  
(US Patent No.:7,648,391 / JP Patent P4616208)

Our new Axial Locking System incorporated in f-TP615 uses a locking set screw that anchors each duplex receptacle to prevent oscillation and enhance long-term stability and blade contact area. The torque applied to each Axial Lock is precisely matched with the 3M material's density for best isolation characteristics.

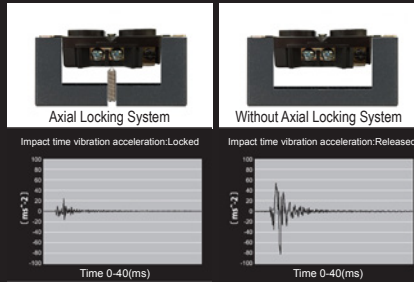

The results show Furutech's patent pending Axial Locking System -- hand-torqued to optimum values during assembly -- reduces noise, oscillation and vibration by a factor of almost ten times!

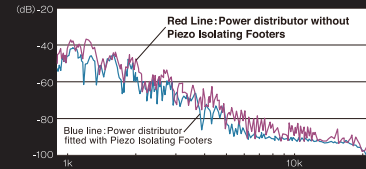

**Piezo Isolating Footers**

The results show that above 4kHz there is an amazing 10dB of resonance suppression, and in tests without Furutech's Piezo Isolating Footers peaks completely vanish at 13kHz. Also with this type of measuring system there is some residual noise, so in actual fact one can expect even greater improvement in vibration and resonance suppression when connected to your system!



**e-TP609 NCF**  
**e-TP609E NCF**  
AC Power Distributor

- Features Axial Locking System
- GC-303 EMI-Absorbent Internal Coating
- Nonmagnetic rhodium-plated α (Alpha) pure copper GTX-D NCF High End Performance Receptacles. Receptacles featuring nylon/fiberglass bodies incorporating carbon particles forming an extremely effective nonresonant connector body
- Chassis CNC machined from solid aluminum block equipped with Piezo nano-ceramic and carbon damping isolator footers (stainless spikes optional)
- Special Vibration Dampening Coating.
- Outputs: 6 Outlets • Input: 15A/125V • 10A/250V IEC
- Rated: 15A/125V
- Also features Furutech's FI-09 NCF Rhodium plated Pure copper IEC Inlet
- Also available in 230V schuko model (e-TP609E NCF)
- US Patent No.:7,648,391 / JP Patent No.:P4616208



"...In practice, the e-TP609 yields a noticeable reduction in background noise and grunge, coupled with a smooth, organic sound that allows music's natural beauty to flow freely."  
--Chris Martens, The Absolute Sound Product of the Year Award



**e-TP80S**  
**e-TP80ES**  
**e-TP80S NCF**  
**e-TP80ES NCF**  
AC Power Filter Distributor



"As good as it gets... a solid value, and the perfect choice for those looking in this price range for a flexible, musical, and well-designed power line conditioner." **Robert Levi, Positive Feedback Online**

- 4 filtered and 4 non-filtered AC Power Distributor featuring Hyper Quality non-magnetic 24K gold-plated outlets (e-TP80S) or Rhodium-plated NCF outlets (e-TP80S NCF)
- GC-303 EMI-Absorbent Internal Coating and an EMI noise filter
- Outputs: 8 special grade receptacles (4 Filtered 4 Non- Filtered) – e-TP80S NCF featuring Furutech's resonance and static eliminating material - NCF
- Input: 15A IEC • 15A/125V
- 230V schuko model (e-TP80ES & e-TP80ES NCF)



**AC Power Distributor featuring GC-303 EMI-Absorbent internal coating; all metal parts treated with Furutech's Cryogenic and Demagnetizing Alpha Process**

- GC-303 EMI-Absorbent Internal Coating
- Outputs: e-TP60 - 6 FPX(G) grade receptacles  
e-TP60E - 6 FI-E30(G) schuko sockets  
e-TP60E NCF - 6 FI-E30 NCF schuko sockets featuring Furutech's resonance and static eliminating material - NCF
- Rated: 15A/125V or 10A/250V

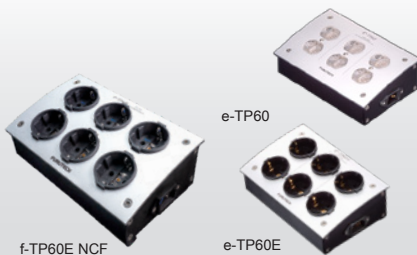

**e-TP60**  
**e-TP60E**  
**e-TP60E NCF**  
AC Power Distributor



**e-TP66(G) e-TP86(G) e-TP66E(G) e-TP86E(G)**  
AC Power Filter Distributor



- High grade aluminum chassis effectively shields against RFI (Radio Frequency Interference)
- Internal wiring: Furutech μ-14 conductor at 2.0 sq. mm (14 AWG) for low electrical resistance
- NEMA models feature Pure Transmission FPX(G) 20A grade high performance receptacles
- Schuko models feature Pure Transmission FI-E30(G) high performance sockets
- High performance FI-06(G) IEC inlet • Special damping material set under duplex receptacle and Schuko socket (Rhodium versions available by request)

# Furutech Top-Tier NCF Series The Ultimate Audiophile Grade Connectors for High Performance and Pro Audio

## Nano Crystal<sup>2</sup> Formula - Nano Crystalline, Ceramic and Carbon Powder

Incorporated into Furutech NCF products, Nano Crystal<sup>2</sup> Formula --- NCF features a special crystalline material that has two 'active' properties. First, it generates negative ions that eliminate static. Second, it converts thermal energy into far infrared. Furutech combines this remarkable material with nano-sized ceramic particles and carbon powder for their additional 'piezoelectric effect' damping properties. The resulting Nano Crystal<sup>2</sup> Formula is the ultimate electrical and mechanical damping material. Created by Furutech, it is found exclusively in Furutech products.

### Features:

- US Patent No.: 7,976,320
- α (Alpha) Pure-Copper Rhodium-plated Conductor
- Earth (Ground) Jumper System (US Patent No.: 6,669,491/European: EP1445837)
- Nylon/fiberglass body with a special anti-resonance nano-sized crystalline, piezo ceramic particles and carbon damping material
- Specified for cable diameters from 6mm to 20mm
- Metal cable clamp improves grip and reduces mechanically and electrically induced distortion
- Dimensions:
  - FI-50 NCF Body length 44mm x 34.5mm diameter / 80.3mm overall length
  - FI-50M NCF Body length 40mm x 34.5mm diameter / 76.2mm overall length
  - FI-E50 NCF Body length 55.4mm x 39.5mm diameter / 93.2mm overall length
  - FI-52 NCF Body length 41.1mm x 34.5mm diameter / 77.2mm overall length
  - FI-52M NCF Body length 40mm x 34.5mm diameter / 75.8mm overall length



## NCF Piezo Ceramic Series AC Connectors • A Furutech First!

Furutech's Pure Transmission FI-50 NCF Piezo Ceramic series connector bodies and housings feature several breakthrough construction techniques. A multilayer nonmagnetic stainless steel and silver plated carbon fiber shell incorporates a special damping and insulating acetal copolymer. Furutech settled on stainless and silver plated carbon fiber for the outer housing after extensive listening sessions with Japanese industry figures and audiophiles. The body of the connectors incorporates NCF damping material: Nano Crystal<sup>2</sup> Formula - Nano Crystalline, Ceramic and Carbon Powder. Nano Crystal<sup>2</sup> Formula eliminates static, "interconverts" thermal, mechanical and electrical energy and damps vibrations—all for the finest Furutech Pure Transmission signal imaginable.

## The Furutech Earth/Ground Jumper System

Furutech's total attention to detail and elegant engineering neatly solves the problem. The Earth/Ground Jumper System connects the securing screws to a ground terminal within the plug completely eliminating the field disturbances they cause. The stray fields are grounded by a series of interlocking parts within the connector that attach to the ground conductor.

## FURUTECH'S TOP-TIER GTX-D NCF RECEPTACLES

# GTX-D

### NCF Nano Crystal<sup>2</sup> Formula

The GTX-D NCF manifests a devotion to best performance in every element of AC and signal transfer. Of course everyone would love to make pure-copper receptacles, but its malleability – lack of stiffness – makes pure copper a poor choice. That's why you'll find phosphor bronze or brass in most receptacles. Furutech's intense engineering scrutiny has resulted in an industry-first, a technique allowing us to use special Furutech rhodium-plated α (Alpha) pure copper conductors strengthened and sprung by our innovative nonmagnetic Stainless Steel Conductor Spring System that keeps a firm grip yet won't damage male connector blades or their plated surfaces. But what really sets the GTX-D NCF receptacle apart is "NCF" – Furutech's ultimate damping material - Nano Crystal<sup>2</sup> Formula eliminates static, "interconverts" thermal, mechanical and electrical energy and damps vibrations. The GTX-D NCF can be summed up in a word; virtuoso!



### Features:

- Rhodium-plated α (Alpha) Pure Copper Conductor (0.8mm) Nonmagnetic stainless conductor spring system
- Body material: Nylon/fiberglass with a special anti-resonance nano-sized crystalline, piezo ceramic particles and carbon damping material
- Cover material: Polycarbonate with a special anti-resonance nano-sized crystalline material "NCF"
- Parts set with nonmagnetic 2.0mm-thick stainless brace plate
- Specified for wire diameters of 4mm (set screw)
- Dimensions: 104.0 mm (L) x 47.2 mm (W) x 28.0 mm (H)



## FI-06 NCF

- ### Features:
- α (Alpha) Pure-Copper Rhodium-plated Conductor
  - Materials: Nylon/fiberglass with special "NCF" anti-resonance damping material - nano-sized crystalline, piezo ceramic particles and carbon powder
  - Specifications: Accommodates wire diameters up to 3.5mm (set-screw)
  - Dimensions: 50.5 (W) x 23.9mm (D) x 33.5mm (H) ± 0.1mm
  - Rated: 15A/250V



## FT-SWS NCF

- ### Features:
- α (Alpha) Pure Copper Main Conductor (t : 0.5mm)
  - 1.0mm thick Bracket with a Zinc/steel brace plate
  - Carbon fiber finished Cast Zn-Mg Alloy Front Plate
  - Specified for wire diameters of 2.8mm or 5.5 Sq.mm/10AWG Max. (set screw)
  - Dimensions: 95.0mm (L) x 95.0mm (W) x 48.0mm(H)
  - Rating: 16A 250V A.C.

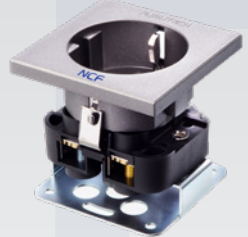

## FT-SDS NCF

- ### Features:
- α (Alpha) Pure Copper Main Conductor (t: 0.5mm)
  - 1.0mm thick Zinc/steel brace plate Base Bracket
  - Specified for wire diameters of 2.8mm or 5.5 Sq.mm/10AWG Max. (set screw)
  - Dimensions: 54.8mm (L) x 54.8mm (W) x 52.0mm(H)
  - Rating: 16A 250V A.C.



## FI-E30 NCF

- ### Features:
- Main conductors: α (Alpha) Pure copper Rhodium plated
  - Dimensions: 50.6mm x 50.6mm x 36.0mm (L x W x H)
  - Rating: 16A 250V A.C.



# High End Performance Audio Accessories

*"One last comment has to go to the finish of the connectors ... Tolerances are spot on, the stuff goes in smoothly, locks and unlocks without any undue play ... There's something luxurious and silken about the Furutech connectors. Like fine Swiss watches. This stuff also routes and drapes easily. ... Since it does perform to a very high standard, getting the tactile satisfaction and pride of ownership bits thrown into the bargain is worth mentioning.*  
– Srajan Ebaen, 6moons.com

## The Furutech Floating Field Damper\*

### Solving the Biggest Problem You Didn't Know You Had

Noise and vibration are primary causes of signal transmission distortion, and controlling them is vital to achieving stable, minimal-loss AC power transfer. Most audiophiles and video enthusiasts assume plugging a power cord into a wall receptacle is the point at which electrical potentials or disturbances are generated; everyone has created a small spark plugging in a device that was On rather than Off. But research has shown that there are many elements in a connector capable of creating stray electrical potentials such as cable clamps, screws and other magnetic parts.

### Magnetic Floating Field Damping

Current flowing through a cable and its connector creates magnetic (and electrostatic) fields around them, building and collapsing 60 times per second in 120VAC systems. This magnetic field induces current flow—electrical potential—in small parts like the screws holding the connector shell together which have to be metal for tight clamping. The current flow in these small parts actually creates “floating” magnetic fields around them, and they interfere with the cable/connector’s larger surrounding magnetic field resulting in noise and distortion.

Conventional AC connector without Floating Field Damper

Noise voltage radiated from power source envelopes the body of a connector which is in a floating field state

AC connector with Furutech Floating Field Damper

Floating field damper ties the housing to ground, preventing radiated noise voltage from surrounding the connector

The Furutech Floating Field Damper solves the biggest problem you never realized you had by star grounding the metal parts in which floating magnetic fields are induced by current flow. As represented in the images below, a precisely engineered, sprung metal bridge in the connector body ties the various metal parts together and shunts whatever electrical potentials generated to ground. This significantly lowers noise by reducing distortion for ultra-clean and stable power transfer.

## Innovations Award-Winning

### FI-50 Piezo Connector Series and New FI-50 NCF Series

The FI-50 NCF series and FI-50 series connectors are crafted from nonmagnetic stainless steel covered with six-layers of piezo-conductive carbon fiber with all metal parts tied to ground with the Floating Field Damper so any noise generated within or around the connector is shunted to ground.

#### 1.Green:

Attenuation of radiated voltage/noise from a power supply line with Floating Field Damper

#### 2.Blue:

Attenuation of radiated voltage/noise surrounding the housing of the connector with Floating Field Damper

The data clearly illustrates that the Floating Field Damper stabilizes power supplied to sensitive audio components while greatly reducing distortion caused by radiated noise voltage resulting in increased low-level information and distortion free, dynamic and clear sound.

**The Earth/Ground Jumper System is available in Furutech NEMA/Schuko and IEC Connectors.**

\* We've renamed our patented Earth/Ground Jumper System to better describe the circuit's engineering and effects.  
(US Patent No.: 6,669,491/European Patent (EP1445837))

The graph below illustrates the Floating Field Damper curbing noise generated between 100kHz and 1GHz.

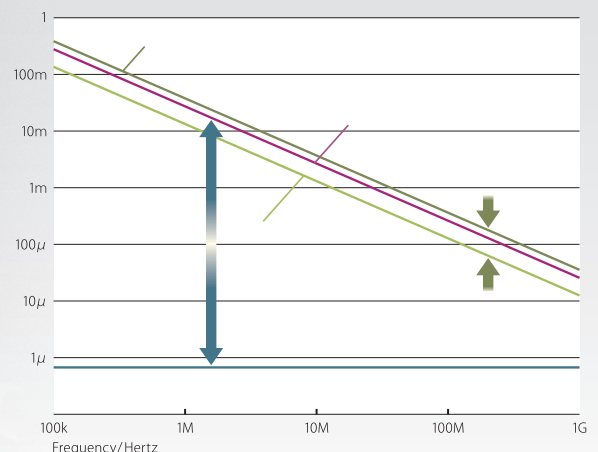

# Piezo Ceramic & Carbon Series Connectors

## Piezo Ceramic Series Connectors • A Furutech First!

The body of the connectors combines two "active" materials: Nano-sized ceramic particles and powdered carbon. (Only nano-sized ceramic particles effectively couples with carbon powder.) Carbon powder exhibits thermal-conductive characteristics that interact with the charged ferro-ceramic particles converting their energy into heat that's conducted away and released from the surface of the connector body! These carefully chosen and tested "active" materials mechanically and electrically damp the connector and receptacle as they "interconvert" thermal, mechanical, and electrical energy for the finest Furutech Pure Transmission signal imaginable.



**FI-50(R)IEC Power Connector**  
**FI-50M(R)AC Power Connector**



- $\alpha$  (Alpha) pure-copper rhodium-plated conductors
- Floating Field Damper function (US Patent No.: 6,669,491/European Patent (EP1445837))
- Piezo Ceramic series connector bodies incorporate ceramic nano-sized particles, carbon powder, nylon and fiberglass
- Multilayered nonmagnetic stainless steel and carbon fiber housing incorporates a special damping insulating acetal copolymer
- Specified for cable diameters from 6mm to 20mm
- Patented metal cable clamp improves grip and reduces mechanically and electrically induced distortion plus patent-pending specially engineered pressure plate

## New NCF Connectors

The very popular FI-48 series now features Furutech's revolutionary anti-static and resonance damping material NCF. Now also available for the first time with silver plating.



**NEW**  
**FI-48(R)NCF & FI-48M(R)NCF**  
**Rhodium-Plated**

**NEW**  
**FI-48(Ag)NCF & FI-48M(Ag)NCF**  
**Silver-Plated**

- $\alpha$  (Alpha) Pure-Copper Rhodium-plated or Silver-plated Conductors
- Floating Field Damper (US Patent No.: 6,669,491/European: EP1445837)
- Nylon/fiberglass body with a special anti-resonance nano-sized crystalline, piezo ceramic particles and carbon damping material
- Beautiful polish finished Nonmagnetic SUS303 housing. The best of damping and insulation materials improve frequency extension and tonal balance.
- Specified for cable diameters from 6mm to 20mm



If your preference is gold plating - a new connector series with NCF antistatic and resonance damping material and a brushed and anodized aluminum housing

**NEW**  
**FI-46(G)NCF & FI-46M(G)NCF**  
**Gold-Plated**



- $\alpha$  (Alpha) Pure-Copper Gold-plated Conductor
- Floating Field Damper System (US Patent No.: 6,669,491/ European: EP1445837)
- Nylon/fiberglass body with a special anti-resonance nano-sized crystalline, piezo ceramic particles and carbon damping material
- Aluminum (6061 T6) housing brushed and anodized. The best of damping and insulation materials improve frequency extension and tonal balance.
- Specified for cable diameters from 6mm to 20mm

## High End Performance Power and IEC Connectors



The FI-28 series feature new resonance damping metal clamps and the FI-28 IEC has pure copper  $\alpha$  (Alpha) conductors.

**FI-28(R) Rhodium-Plated**   **FI-28(G) 24k Gold-Plated**

- $\alpha$  (Alpha) Pure copper Conductor parts
- Floating Field Damper function (US Patent No.: 6,669,491/European Patent (EP1445837))
- Nylon/fiberglass front body • polycarbonate shell
- Specified for cable diameters of 6.6mm to 17.5mm
- Patent pending metal cable clamp improves grip and reduces mechanically and electrically induced distortion plus patent-pending specially engineered pressure plate
- Wire accommodation: Max. 5.5 square mm   Max. 10 AWG
- Dimensions: Body length 43.9mm x 39.6mm diameter x 76.2mm overall length
- Rated: 15A/125V 10A/250V

**FI-28M(R) Rhodium-Plated**   **FI-28M(G) 24k Gold-Plated**

- $\alpha$  (Alpha) Pure copper Conductor parts
- Floating Field Damper function (US Patent No.: 6,669,491/European Patent (EP1445837))
- Nylon/fiberglass front body • polycarbonate shell
- Specified for cable diameters of 6.6mm to 17.5mm
- Patent pending metal cable clamp improves grip and reduces mechanically and electrically induced distortion plus patent-pending specially engineered pressure plate
- Wire accommodation: Max. 5.5 square mm   Max. 10 AWG
- Dimensions: Body length 40.2mm x 39.6mm diameter x 72mm overall length
- Rated: 15A/125V



## High Performance Angled Power Connector Series

The world's first high-end grade angled power connectors. All versions with adjustable angle settings (4 settings) and featuring Furutech's top rhodium-plated  $\alpha$  (Alpha) pure-copper conductors.



### FI-12L(R)



### FI-12ML(R)



### FI-E12L(R)



- Rhodium-plated  $\alpha$  (Alpha) pure-copper conductors
- Floating Field Damper System (US Patent No.: 6,669,491/European Patent (EP1445837))
- Nylon/fiberglass body incorporating carbon particles that absorb vibration and resonance
- Specified for cable diameters from 6.6mm to 18.0mm
- Metal cable clamp improves grip and reduces mechanically and electrically induced distortion
- Dimensions: Housing-44.0mm X 42.2mm X 55.0mm
- FI-12L(R) — 70.6mm Overall Length X 42.2mm X 55.0mm Approx.
- FI-12ML(R) — 66.4mm Overall Length X 42.2mm X 55.0mm Approx.
- FI-E12L(R) — 84.0mm Overall Length X 42.2mm X 55.0mm Approx.
- Rating: FI-12L(R)—10A 250V /15A 125V AC // FI-12ML(R)—15A 125V AC // FI-E12L(R)—16A 250V



### FI-11-N1(R) Rhodium-Plated

- $\alpha$  (Alpha) Phosphor bronze Conductor
- Floating Field Damper function (US Patent No.: 6,669,491/European Patent (EP1445837))
- Nylon/fiberglass front body, polycarbonate shell
- Specified for cable diameters of 6.6mm to 16mm (With a longer screw up to 20mm)
- Wire accommodation: Max. 5.5 square mm Max. 10 AWG
- Dimensions: Body length 43.9mm x 39mm diameter x 76.8mm overall length
- Rated: 15A/125V 10A/250V



### FI-11M-N1(R) Rhodium-Plated

- $\alpha$  (Alpha) Pure Copper Conductor
- Features improved plating and new metal cable clamp for resonance damping and firm grip
- Floating Field Damper function (US Patent No.: 6,669,491/European Patent (EP1445837))
- Nylon/fiberglass front body, polycarbonate shell
- Specified for cable diameters of 6.6mm to 16mm (With a longer screw up to 20mm)
- Wire accommodation: Max. 5.5 square mm Max. 10 AWG
- Dimensions: Body length 40.0mm X 39.0mm dia. X 73.0mm overall length
- Rated: 15A/125V



### FI-11-N1(G) 24k Gold-Plated FI-11-N1(Ag) Silver Plated

- $\alpha$  (Alpha) Phosphor bronze Conductor
- Features improved plating and new metal cable clamp for resonance damping and firm grip
- Floating Field Damper function (US Patent No.: 6,669,491/European Patent (EP1445837))
- Nylon/fiberglass front body, polycarbonate shell
- Specified for cable diameters of 6.6mm to 16mm (With a longer screw up to 20mm)
- Wire accommodation: Max. 5.5 square mm Max. 10 AWG
- Dimensions: Body length 43.9mm x 39mm diameter x 76.8mm overall length
- Rated: 15A/125V 10A/250V



### FI-11M-N1(G) 24k Gold-Plated

- $\alpha$  (Alpha) Pure copper Conductor
- Features improved plating and new metal cable clamp for resonance damping and firm grip
- Floating Field Damper function (US Patent No.: 6,669,491/European Patent (EP1445837))
- Nylon/fiberglass front body • Polycarbonate shell
- Specified for cable diameters of 6.6mm to 16mm (With a longer screw up to 20mm)
- Wire accommodation: Max. 5.5 square mm Max. 10 AWG
- Dimensions: Body length 40.2mm x 39mm diameter x 73mm overall length
- Rated: 15A/125V



### FI-11(Cu) Unplated

- $\alpha$  (Alpha) Phosphor bronze Conductor
- Floating Field Damper function (US Patent No.: 6,669,491/European Patent (EP1445837))
- Nylon/fiberglass front body, polycarbonate shell
- Specified for cable diameters of 6.6mm to 16mm (With a longer screw up to 20mm)
- Wire accommodation: Max. 5.5 square mm Max. 10 AWG
- Dimensions: Body length 43.9mm x 39mm diameter x 76.8mm overall length
- Rated: 15A/125V 10A/250V



### FI-11M(Cu) Unplated

- $\alpha$  (Alpha) Pure copper Conductor
- Floating Field Damper function (US Patent No.: 6,669,491/European Patent (EP1445837))
- Nylon/fiberglass front body • Polycarbonate shell
- Specified for cable diameters of 6.6mm to 16mm (With a longer screw up to 20mm)
- Wire accommodation: Max. 5.5 square mm Max. 10 AWG
- Dimensions: Body length 40.2mm x 39mm diameter x 73mm overall length
- Rated: 15A/125V



### FI-15-Plus(R)

Rhodium-Plated

### FI-15-Plus(G)

24k Gold-Plated

- Rhodium or 24k gold-plated  $\alpha$  (Alpha) Pure copper Conductor
- Floating Field Damper System\* prevents induced magnetic fields
- (US Patent No.: 6,669,491/European Patent (EP1445837))
- Nylon /fiberglass main body and inner cover plate.
- Specified for cable diameters of 6.6mm to 15.0mm (Wire size of 5.5 square mm (10AWG) max.)
- Polycarbonate cable damping clamp with stainless screws
- Rated: 15A 125V / 10A 250V A.C.
- Connection: Set screw
- Dimensions: 35.0mm X 34.0mm X 72.5mm overall length.



### FI-15M-Plus(R)

Rhodium-Plated

### FI-15M-Plus(G)

24k Gold-Plated

- Rhodium or 24k gold-plated  $\alpha$  (Alpha) Pure copper Conductor
- Floating Field Damper System\* prevents induced magnetic fields
- (US Patent No.: 6,669,491/European Patent (EP1445837))
- Nylon /fiberglass main body and inner cover plate.
- Specified for cable diameters of 6.6mm to 15.0mm (Wire size of 5.5 square mm (10AWG) max.)
- Polycarbonate cable damping clamp with stainless screws
- Rated: 15A 125V A.C.
- Connection: Set screw
- Dimensions: 35.0mm X 34.0mm X 72.2mm overall length.



### FI-15E (Cu)

Unplated

### FI-15ME (Cu)

Unplated

- $\alpha$  (Alpha) Pure copper Conductor
- Floating Field Damper function (US Patent No.: 6,669,491/ European Patent No. EP1445837)
- Nylon / fiberglass housing
- Specified for cable diameters of 6.6mm to 13mm
- Wire accommodation: Max. 3.5 square mm Max. 12 AWG
- FI-15E(Cu):
- Dimensions: 31mm x 33.3mm x 72.0mm overall length
- Rated: 15A/125V 10A/250V
- FI-15ME(Cu):
- Dimensions: 31mm x 33.3mm x 72.0mm overall length
- Rated: 15A/125V



### FI-8N(R) NCF

Rhodium-Plated

### FI-8N(G)

24k Gold-Plated

- Furutech's unique female conductor design features rhodium-plated  $\alpha$  (Alpha) beryllium copper and phosphor bronze conductors.
- Nylon / fiberglass with special "NCF" anti-resonance damping material - nano-sized crystalline, piezo ceramic particles and carbon powder main body.
- Specified for cable outer diameters of 6.0mm-13.0mm.
- Wire accommodation: Max. 2.4mm dia.(Solid core) // 2.0 Sq.mm/14AWG (Strand wire)
- Connection: Set screw.
- Dimensions: 36.8mm X 28.2mm X 71.0 mm  $\pm$  0.5mm overall length approx.
- Net Weight: 51.4g approx.



# High End Performance Slimline IEC connector Series



**NCF** <sup>NEW</sup> <sup>AWARD 2020</sup>  
New slimline "figure8" IEC connector

**FI-8.1N NCF(R)**

Rhodium-Plated

**FI-8.1N(G)**

Gold-Plated

- Rhodium-plated or Gold-plated α (Alpha) Phosphor Bronze Conductor.
- FNylon / fiberglass body - FI-8.1N(R) NCF with special "NCF" anti-resonance damping material - nano-sized crystalline, piezo ceramic particles and carbon powder
- Specified for cable outer diameters of 5.0mm / 10.5mm.
- Wire accommodation: Max. 2.0 Sq.mm / 14AWG.
- Connection: Solder
- Dimensions: 14.5mm X 21.5mm X 51.2mm overall length approx.
- Rating: 7A 125V / 2.5A 250V AC



**NCF**

**FI-C15 NCF(R)**

Rhodium-Plated

**FI-C15(G)**

24k Gold-Plated

- Rhodium or 24k gold-plated α (Alpha) Pure copper Conductor
- Nylon /fiberglass main body and inner cover plate. NCF version with Nano Crystal Formula damping material.
- Specified for cable diameters of 6.6mm to 16.0mm (Wire size of 3.5 square mm (12AWG) max.)
- Polycarbonate cable damping clamp with stainless screws
- Connection: Set screw
- Dimensions: 22.0mm X 30.0mm X 83.2mm overall length.
- Rating: 15A 125V / 10A 250V A.C.



## High End Performance 20A Components

We feature an expanding range of beautifully engineered and built, reliable, and very effective 20A components to deliver a dynamic and powerful sound and significantly improved picture quality.



**FI-32M(R) FI-32(R)**

Rhodium-Plated 20A AC Connector

- High End Performance 20A Connectors
- α (Alpha) Pure Copper Conductor
- Earth (Ground) Jumper System (US Patent No.: 6,669,491/European Patent (EP1445837))
- Patent pending metal cable clamp improves grip and reduces mechanically and electrically induced distortion plus patent-pending specially engineered pressure plate
- Nylon/fiberglass front body • Polycarbonate shell
- Specified for cable diameters of 6.6mm to 17.5mm
- Wire accommodation: Max. 5.5 Square mm Max. AWG 10
- Rated: FI-32M(R):20A/125V, FI-32(R):20A/125V, 16A/250V

**FI-31(G)**

24k Gold-Plated 20A IEC

- High Performance 20A Connectors
- α (Alpha) Phosphor bronze Conductor
- Earth (Ground) Jumper System(US Patent No.: 6,669,491/European Patent (EP1445837))
- Material: Nylon/fiberglass • Polycarbonate shell
- Specified for cable diameters of 6.6mm to 20.0mm
- Wire accommodation: Max. 5.5 square mm Max. AWG 10
- Rated: 20A/125V 16A/250V



**FI-52(R) 20A IEC Power Connector**

**FI-52M(R) 20A AC Power Connector**

Rhodium-Plated

- US Patent No.: 7,976,320
- α (Alpha) pure-copper rhodium-plated conductors
- Floating Field Damper function (US Patent No.: 6,669,491/European Patent (EP1445837))
- Piezo Ceramic series connector bodies incorporate ceramic nano-sized particles, carbon powder, nylon and fiberglass
- Multilayered nonmagnetic stainless steel and carbon fiber housing incorporates a special damping insulating acetal copolymer
- Specified for cable diameters from 6mm to 20mm
- Patented metal cable clamp improves grip and reduces mechanically and electrically induced distortion plus patent-pending specially engineered pressure plate

## High End Performance filter IEC inlets



**NCF**

**FI-09 NCF(R) FI-09(G)**

Rhodium-Plated

24k Gold-Plated

- α (Alpha) Pure copper Conductor
- Materials: Nylon/fiberglass
- Specifications: Accommodates cable diameters to 4mm (set-screw)
- Wire accommodation: Max. 5.5 square mm Max. 10 AWG
- Dimensions: 60 (W) x 30mm (D) x 36.2mm (H)
- Rated: 15A/250V

**NCF**

**FI-06 NCF(R) FI-06(G)**

Rhodium-Plated

24k Gold-Plated

- α (Alpha) Pure Copper Conductor
- Materials: Nylon/fiberglass
- Accommodates wire diameters up to 3.5 square mm Max. 12 AWG
- Connection: Set screw
- Dimensions: 50.5 (W) x 23.9mm (D) x 33.5mm (H) ±0.1mm
- Rated: 15A/250V

**NCF**

**FI-33NCF(R) FI-33(G)**

Rhodium-Plated

24k Gold-Plated

- High End Performance 20A IEC Inlet
- α (Alpha) Pure copper Conductor
- Material: Nylon/fiberglass
- Rated: 20A/125V and 16A/250V



**FI-03(R) FI-03(G)**

Rhodium-Plated

24k Gold-Plated

- α (Alpha) Copper Alloy Conductor
- Nylon and fiberglass housing
- High grade contact fuse holder
- Dimensions: 44.0mm (W) x 28.6mm (D) x 33.0 (H)
- Rated: 10A/250V
- Standard : IEC 320-1 C14



**INLET(R)**

Rhodium-Plated

**INLET(G)**

24k Gold-Plated

- α (Alpha) Eutectic (low temperature) cast Copper Alloy Conductor
- PBT and fiberglass housing
- Connections: Soldered
- Dimensions: 49.5mm (W) x 22.0mm (D) x 27.5 mm (H)
- Rated: 15A/250V(for UL,CSA),10A/250V(for Others)



# High End Performance 20A 125V Duplex and Single Receptacles



**NCF Nano Crystal<sup>2</sup> Formula**  
FURUTECH'S TOP-TIER GTX-D NCF RECEPTACLES



Furutech's Top-Tier GTX-D NCF Receptacle and GTX series Refinement has a New Name...  
Of course everyone would love to make pure-copper receptacles, but its malleability – lack of stiffness – make pure copper a poor choice. That's why you'll find phosphor bronze or brass in some receptacles. Furutech's intense engineering scrutiny has resulted in an industry-first, a technique allowing us to use special Furutech 24k gold- or rhodium-plated  $\alpha$  (Alpha) pure copper conductors strengthened and sprung by our innovative nonmagnetic Stainless Steel Conductor Spring System that keeps a firm grip yet won't damage male connector blades or their plated surfaces.  
**US Patent No. 8,133,064**

For more NCF product details see P.10



**Top-Tier GTX-D NCF**

Rhodium-Plated duplex receptacle  
• US Patent No.:8,133,064



**Top-Tier GTX-S NCF**

Rhodium-Plated single receptacle



**GTX-D(R) GTX-D(G)**

Rhodium-Plated duplex receptacle      Gold-Plated duplex receptacle

- US Patent No.:8,133,064
- Rhodium or gold-plated  $\alpha$  (Alpha) Pure Copper Conductor (0.8mm)
- Nonmagnetic stainless conductor spring system
- Materials: Nylon/fiberglass body and polycarbonate cover; parts fixed with 2.0mm-thick stainless brace plate
- Specified for wire diameters of 4mm (set screw)
- Dimensions: 104.0mm (L) x 47.2mm (W) x 28.0mm(H)

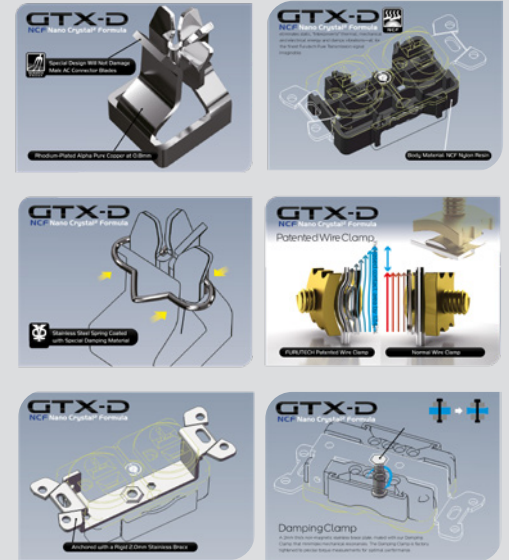

## GTX Wall Plate



Beautifully crafted special grade aluminum CNC processed chassis effectively shields against RFI and finished with an extremely effective nonresonant coating and special Fluoropolymer damping foil for installation.

## High End Performance 15A or 20A 125V Duplex Receptacle

Many A/V enthusiasts go to great lengths in carefully setting up major system components, but pay little attention to AC power. Furutech knows that each and every part of the chain is as important as the next, so maximum attention is lavished by Furutech's engineers on all aspects of power transfer to set new benchmarks of performance.  
Unique pin insert construction ensures increased contact areas, stable transmission and the tightest contacts in the Audio industry and they won't scratch or mark the plating on male AC connectors!

**FPX(R)**

**FPX(G)**

**FPX(Cu)**



- $\alpha$  (Alpha) Phosphor Bronze Conductor (t : 0.8mm)
- Material: Nylon/fiberglass body, Polycarbonate cover;

- Specified for wire diameters of 4mm (set screw) 10 AWG to 24 AWG.
- Dimensions: 104.2mm x 33.5mm (L x W), 28.2mm thick.
- Approvals: UL/CUL

## High End Performance Single and Double Receptacle Covers



**Outlet cover 106-D/106-S NCF**

NCF Damper Outlet Cover 106-D NCF is Furutech's "Top of the line" Receptacle Cover. After a multitude of tests involving the best in damping materials, Furutech brings you its masterpiece. This combination of carbon and NCF will be the final touch to your complete AC chain.



**Outlet cover 102-S/102-D**

The 102-D duplex and 102-S single Receptacle Cover Plates employ Piezo Material to reduce mechanically-induced distortion using the principles of molecular friction and piezoelectric loss improving every aspect of sound reproduction.



# Carbon Fiber Series Connectors

## High End Performance DIN Connector CF-DIN(R)

- Rhodium-plated  $\alpha$  (Alpha) Phosphor bronze conductor
- Fluoropolymer Insulated Body
- Nonmagnetic stainless steel Housing
- Conductor wire fixed by soldering.
- Specified for cable diameters max. 11.0mm
- Dimensions: CF-DIN---14.2mm diameter x 40.2mm overall length

## High End Performance RCA Connector CF-102(R)

- $\alpha$  (Alpha) OCC rhodium-plated center conductor
- $\alpha$  (Alpha) Copper Alloy rhodium-plated Body
- Carbon fiber and nonmagnetic stainless steel Housing
- Conductor wire fixed by set screw
- Specified for cable diameters max. 9.3mm
- Dimensions: 14.0mm diameter x 54.0mm overall length
- Featuring specially engineered set screw construction to ensure firm contact with Alpha OCC conductor



## High End Performance Spade Connector CF-201(R)

- $\alpha$  (Alpha) Pure Copper rhodium-plated center conductor
- $\alpha$  (Alpha) Nonmagnetic stainless steel body
- Carbon fiber and Nonmagnetic stainless steel housing
- Conductor wire fixed by screw set or soldering.
- Specially designed fixed wire construction to ensure the stability of the conductor's contact.
- Specified for wire diameters max. 5.5mm
- Dimensions: 15.2mm diameter x 70.0mm overall length
- Featuring specially engineered set screw construction to ensure firm contact with Alpha Pure Copper conductor
- US Patent No.: 7,976,352 / JP Patent P5020344



## High End Performance Banana Connector CF-202(R)

- $\alpha$  (Alpha) Pure Copper rhodium-plated center conductor
- $\alpha$  (Alpha) Nonmagnetic stainless steel body
- Carbon fiber and Nonmagnetic stainless steel housing
- Conductor wire fixed by screw set or soldering.
- Specially designed fixed wire construction to ensure the stability of the conductor's contact.
- Specified for wire diameters max. 5.5mm
- Dimensions: 15.2mm diameter x 64.2mm overall length
- Featuring specially engineered set screw construction to ensure firm contact with Alpha Pure Copper conductor
- US Patent No.: 7,976,352 / JP Patent P5020344



## High End Performance RCA Connector CF-126(R)

- $\alpha$  (Alpha) -OCC Conductor center pin
- Copper Alloy body and Fluoropolymer insulation
- Connections: Soldered
- Specified for cable diameters up to 7.3mm
- Dimensions: 13.0mm  $\pm$  0.1mm diameter x 39.3mm overall length

## High End Performance BNC Connector CF-BNC(R) 75 $\Omega$

- Nonmagnetic Rhodium-plated  $\alpha$  (Alpha) Phosphor bronze conductor
- Insulation with Fluoropolymer PTFE Resin
- Housing: Nonmagnetic stainless and carbon fiber finished.
- Cable Clamp: Copper Alloy.
- Specified for wire outer diameters up to 8.0mm
- Connections: Soldered
- Dimensions: Housing--- $\phi$ 13.4mmx 22 mm length; Total overall length: 43.9 mm approx.

## High End Performance XLR Connector CF-601M(R) CF-602F(R)

- $\alpha$  (Alpha) Beryllium copper and phosphor bronze Rhodium-plated Conductor
- Carbon fiber and nonmagnetic stainless steel housing
- Body: PVDF insulation
- Specially designed internal cable strain relief.
- Connections: Soldered
- Specified for cable diameters up to 10.0mm (Standard version)
- CF-601M R Dimensions: 18.6mm  $\pm$  0.1mm diameter x 65.5mm  $\pm$  0.1mm overall length.
- CF-602F R Dimensions: 18.6mm  $\pm$  0.1mm diameter x 77.4mm  $\pm$  0.1mm overall length.

# High End Performance Headphone Connectors

## 2.5mm 4 Pole Balanced Connector CF-7254(R)

- Main conductor: Rhodium-plated  $\alpha$  (Alpha) Pure copper conductor
- Ground conductor: Rhodium-plated  $\alpha$  (Alpha) Copper Alloy.
- Insulation: Special audio grade P.P Resin
- Housing: stainless and carbon fiber finished.
- Cable Clamp: Copper Alloy
- Specified for core insulation diameters up to 5.3mm
- Connections: Soldered

## 2.5mm 4 Pole Balanced Connector FT-7254(R)

- Main conductor: Rhodium-plated  $\alpha$  (Alpha) Pure copper conductor
- Ground conductor: Rhodium-plated  $\alpha$  (Alpha) Copper Alloy.
- Insulation: Special audio grade P.P Resin
- Housing: Stainless.
- Cable Clamp: Copper Alloy
- Specified for core insulation diameters up to 5.0mm
- Connections: Soldered



## Headphone Connectors CF-H800

- Nonmagnetic Rhodium-plated  $\alpha$  (Alpha) Phosphor bronze conductor
- Insulation with Nylon+Fiberglass15% Resin
- Main Body: Nonmagnetic stainless with Carbon Fiber finish
- End Ring: Nonmagnetic stainless.
- Fixed Tube: Copper Alloy.
- Connections: Soldered
- Specified for core insulation diameters up to 3.8mm

## Headphone Connectors FT-H800

- Nonmagnetic Rhodium-plated  $\alpha$  (Alpha) Phosphor bronze conductor
- Insulation with Nylon+Fiberglass15% Resin
- Main Body: Nonmagnetic stainless.
- End Ring: Nonmagnetic stainless.
- Fixed Tube: Copper Alloy.
- Connections: Soldered
- Specified for core insulation diameters up to 3.8mm

## 6.3mm Stereo Connectors FT-763SM(R)

- Conductor: Rhodium-plated  $\alpha$  (Alpha) Phosphor bronze
- Insulation: audio grade Nylon Glass Fiber Resin
- Housing: Nonmagnetic stainless.
- Cable Clamp: Copper Alloy.
- Specified for core insulation diameters up to 8.0mm
- Connections: Soldered

## 6.3mm Stereo Connectors CF-763SM(R)

- Conductor: Rhodium-plated  $\alpha$  (Alpha) Phosphor bronze
- Insulation: audio grade Nylon Glass Fiber Resin
- Housing: Nonmagnetic stainless with Carbon Fiber finish.
- Cable Clamp: Copper Alloy.
- Specified for core insulation diameters up to 8.0mm
- Connections: Soldered

## 3pin mini XLR Female Connector FT-608mF

- Nonmagnetic Rhodium-plated  $\alpha$  (Alpha) Phosphor bronze conductor
- Super heat resistant Polyphenylene Sulfide Resin Insulation for best soldering results
- Housing: Nonmagnetic stainless.
- Cable Clamp: Superior Damping Copper Alloy.
- Specified for core insulation diameters up to 5.0mm
- Connections: Soldered

## 4pin mini XLR Female Connector FT-610mF

- Main conductor: Nonmagnetic Rhodium-plated  $\alpha$  (Alpha) Phosphor bronze conductor
- Super heat resistant Polyphenylene Sulfide Resin Insulation for best soldering results
- Housing: Nonmagnetic stainless (Black)
- Cable Clamp: Superior Damping Copper Alloy.
- Specified for core insulation diameters up to 5.0mm
- Connections: Soldered

## 3.5mm Stereo Connector CF-735SM(R)

- Main conductor: One piece Rhodium-plated  $\alpha$  (Alpha) Pure copper conductor
- Ground conductor: Rhodium-plated  $\alpha$  (Alpha) Copper Alloy.
- Insulation :audio grade Nylon Glass Fiber Resin
- Housing: Nonmagnetic stainless and carbon fiber finished.
- Cable Clamp: Copper Alloy
- Specified for core insulation diameters up to 5.3mm
- Connections: Soldered



## 3.5mm Stereo Connectors FT-735SM(R)

- Main conductor: One piece Rhodium-plated  $\alpha$  (Alpha) Pure copper conductor
- Ground conductor: Rhodium-plated  $\alpha$  (Alpha) Copper Alloy.
- Insulation :audio grade Nylon Glass Fiber Resin
- Housing: Nonmagnetic stainless.
- Cable Clamp: Copper Alloy
- Specified for core insulation diameters up to 5.0mm
- Connections: Soldered



## CF35(R)Carbon fiber finished F35(R)Rhodium plated F35(G)24k Gold-plated

- 6.3mm stereo to 3.5mm stereo adaptor
- $\alpha$  (Alpha) phosphor bronze and copper alloy
- Insulation: POM resin.
- Housing Material: SUS 304.
- Overall Size: 10.6mm X 61.0mm (L) approx.

## CF63-S(R)Rhodium plated F63-S(R)Rhodium plated F63-S(G)24k Gold-plated

- 3.5mm stereo to 6.3mm stereo adaptor
- $\alpha$  (Alpha) phosphor bronze and copper alloy
- Insulation: POM resin.
- Housing Material: SUS 304.
- Overall Size: 9.5mm X 48.5mm(L) approx.

## 2pin Connector FT-2PS-F

- Nonmagnetic Rhodium-plated  $\alpha$  (Alpha) Phosphor bronze conductor
- Insulation body injected with Liquid Crystal Polymer Resin
- Housing cover: Matte black finished Nylon/fiberglass with piezo ceramic resin.
- Cable Clamp: Copper Alloy for best damping effect.
- Specified for core insulation diameters up to 3.5mm

## 4.4mm Balanced TRRS Connectors CF-7445(R)Rhodium plated FT-7445(R)Rhodium plated

- Main conductor: One-piece rhodium-plated  $\alpha$  (Alpha) Copper alloy conductor.
- Ground conductor: Rhodium-plated  $\alpha$  (Alpha) Copper alloy conductor.
- Insulation: Audio Grade POM.
- Housing: Stainless (CF-7445 Carbon Fiber and Stainless).
- Cable Clamp: Copper Alloy.
- Specified for core insulation diameters up to 6.0mm.
- Connections: Soldered.





# High End Performance RCA Connectors

Furutech introduces the CF-102 NCF top-of-the-line RCA connector. This is the first Furutech high performance "signal" connector to feature Nano Crystal Formula (NCF). This material is the cumulative result of Furutech's 30 plus year effort to eliminate electrical and mechanical resonance from signal and power transmission in high performance audio and video applications. Offering a dramatic reduction in noise, improved imaging, and focus, and improved sound staging, the CF-102 NCF will take your listening enjoyment to the next level.

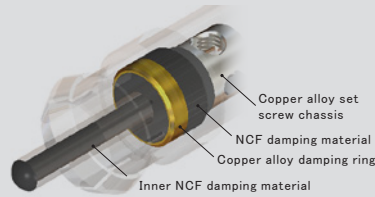

## CF-102 NCF



- $\alpha$  (Alpha) OCC Rhodium-plated one-piece construction conductor tube, pin injected with heat resistant NCF Liquid Crystal Polymer Resin. NCF delivers improvements in the depth and focus of the sound stage, harmonics and tonal balance. Low frequencies are cleaner, with a greater sense of definition made possible by a lowered noise floor
- $\alpha$  (Alpha) Copper Alloy Rhodium-plated Body
- Housing: Multilayer hybrid NCF carbon housing composed of an outer hard clear coat over with another layer of Hybrid NCF Silver plated 3k carbon fiber on a nonmagnetic stainless-steel Housing. The best of damping and insulation materials improve frequency extension and tonal balance.
- Specified for cable diameters max. 11.0mm



## 24k Gold-Plated FP-110(G)

- $\alpha$  (Alpha) -OCC Conductor center pin
- Copper Alloy body and locking collet • Fluoropolymer insulation
- Connections: Soldered
- Specified for cable diameters up to 9.3mm
- Dimensions: 13.8mm  $\pm$  0.1mm diameter x 51.5mm overall length



## Rhodium-Plated FP-108(R)



- $\alpha$  (Alpha) -OCC Conductor center pin
- Copper Alloy body and locking collet • Fluoropolymer insulation
- Connections: Set screw
- Specified for cable diameters up to 9.3mm
- Dimensions: 13.8mm  $\pm$  0.1mm diameter x 54mm  $\pm$  0.1mm overall length



## Rhodium-Plated FP-120(R)

- $\alpha$  (Alpha) Solid OCC center pin
- Copper Alloy body and locking collet
- Fluoropolymer insulation
- Connections: Soldered
- Specified for cable diameters up to 12.3mm
- Dimensions: 13.8mm  $\pm$  0.1mm diameter x 61.2mm  $\pm$  0.1mm overall length



## FP-126(R) Rhodium-Plated FP-126(G) 24k Gold-Plated

- $\alpha$  (Alpha) -OCC Conductor center pin
- Copper Alloy body and Fluoropolymer insulation
- Connections: Soldered
- Specified for cable diameters up to 7.3mm
- Dimensions: 12.6mm  $\pm$  0.1mm diameter x 39.3mm overall length

## High Performance Audio BNC Connector



## Rhodium-Plated FP-3-117(R)

- $\alpha$  (Alpha) Copper Alloy center pin
- Rhodium-plated Copper Alloy body with Fluoropolymer insulation
- Connections: Soldered
- Specified for cable diameters up to 8mm
- Dimensions: 14mm  $\pm$  0.1mm diameter x 43mm  $\pm$  0.1mm overall length
- 75  $\Omega$   $\pm$  3  $\Omega$



## FT-111(R) Rhodium-Plated FT-111(G) 24k Gold-Plated



The FT-111 features an  $\alpha$  (Alpha) pure copper one piece conductor for minimal impedance and nonmagnetic SUS set screw construction design, extremely nonresonant SUS housing and ABS/PC compound insulated body

- $\alpha$  (Alpha) One piece Pure Copper tube conductor
- Plus polarity:  $\alpha$  (Alpha) Pure copper tube injected with ABS/PC compound resin
- SUS housing and ABS/PC compound insulated body
- Connections: Set screws
- Specified for core insulation diameters up to 10.0mm
- End Ring: Anodized Aluminum
- Housing dimensions: ---  $\phi$  14.0mm x 26.5mm overall length
- Total overall length: 50.6 mm approx.

## High Performance Audio RCA Connectors



## 24k Gold-Plated FP-160(G)

- $\alpha$  (Alpha) Copper Alloy center pin
- Copper Alloy body and locking collet • Fluoropolymer insulation
- Connections: Soldered
- Specified for cable diameters up to 9.3mm
- Dimensions: 14.8mm  $\pm$  0.1mm diameter x 52.1mm  $\pm$  0.1mm overall length



## 24k Gold-Plated FP-162(G)

- $\alpha$  (Alpha) Copper Alloy center pin
- Copper Alloy body and Fluoropolymer insulation
- Connections: Soldered
- Specified for cable diameters up to 7.3mm
- Dimensions: 11.9mm  $\pm$  0.1mm diameter x 37.3mm  $\pm$  0.1mm overall length

## High Performance Audio Banana Connectors



## FP-200B(R) Rhodium-Plated FP-200B(G) 24k Gold-Plated

- $\alpha$  (Alpha) Phosphor bronze pins
- Connections: Set-screw
- Specified for wire diameters up to 5mm
- Dimensions: Housing---  $\phi$  10.8 mm X 30 mm L ; Banana Conductor---  $\phi$  4.4 mm X 19.5 mm L
- Overall length : 49.50 mm.



## FP-202(R) Rhodium-Plated FP-202(G) 24k Gold-Plated

- $\alpha$  (Alpha) Copper Alloy pins
- Connections: Set-screw
- Specified for wire diameters up to 5.5mm
- Dimensions: 12mm diameter , 26.7mm  $\pm$  0.1mm (H) x 46mm overall length



## FT-212(R) Rhodium Plated FT-212(G) 24k Gold-Plated



The FT-212 features an  $\alpha$  (Alpha) pure-copper conductor yielding minimal impedance. The conductor is housed in an extremely nonresonant POM resin body with a shell crafted of nylon and fiberglass using Furutech's outstanding Piezo Ceramic damping material. The pin locks feature a new patent-pending mechanism for a secure, reliable grip. It's difficult to find better...

- Main conductor: Rhodium or 24k gold-plated  $\alpha$  (Alpha) pure copper
- Housing: Black nylon/fiberglass with Piezo Ceramic resin
- Body Insulation: Black POM resin injection
- Termination: Set screw
- Specified for core diameters up to 4.2mm
- Specified for core insulation diameter up to 7.8mm
- End Ring: Stainless steel
- Dimensions: Housing: 18.0 X 16.0  $\phi$  x 19.8mm (H) overall height
- Total overall length: 56.0 mm approx.

# High End Performance XLR Connectors

Furutech introduces the CF-601M NCF & CF-602F NCF top-of-the-line XLR connectors. This is Furutech's first high-performance balanced signal connector to feature Nano Crystal<sup>2</sup> Formula (NCF). This material is the cumulative result of Furutech's 30 plus year effort to eliminate electrical and mechanical resonance from signal and power transmission in high performance audio and video applications. Offering a dramatic reduction in noise, improved imaging, and focus, and improved sound staging, the CF-601M NCF & CF-602F NCF will take your listening enjoyment to the next level.



CF-601M NCF   
CF-602F NCF

*"I salute Furutech's engineers for the grind of overhauling the legacy XLR plug and endowing it with their proprietary Nano Crystal<sup>2</sup> Formula. Isn't it amazing that solely for our playback entertainment, their engineers would labour over creating a better connector? I do believe that they did just that, exactly."*

*... "For decades already, Furutech connectors have been the choice of the most prestigious high-end cable brands. From the same firm now comes and even better XLR and RCA plug. That's cause for applause; and a humble thank you!"*

— Srajan Ebaen of 6moons.com

- Rhodium-plated α (Alpha) Pure copper one-piece construction conductor pin injected with heat resistant NCF Liquid Crystal Polymer Resin.
- Special "NCF" antiresonance damping material main body combine heat resistant NCF Liquid Crystal Polymer Resin.
- Hybrid NCF Silver plated 3k carbon fiber on a nonmagnetic stainless-steel Housing.
- Conductor wire fixed by set screw or soldering.
- Accommodates:
  - Specified for cable diameters max. 10.0mm.
- CF-601M NCF—14AWG (2.08 sq.mm) max. stranded wire / 12AWG (3.3 sq.mm) max solid core wire. Wire diameter 2.1mm max.
- CF-602F NCF—13AWG (2.62 sq.mm) max. stranded wire / 12AWG (3.3 sq.mm) max solid core wire. Wire diameter 2.4mm max.

## High End Performance XLR Connectors



- Dimensions:
  - FP-601M: 19.5mm ± 0.1mm diameter x 48.5mm ± 0.1mm overall length
  - FP-602F: 19.5mm ± 0.1mm diameter x 54.2mm ± 0.1mm overall length

Rhodium-Plated 24k Gold-Plated  
FP-601M(R) FP-601M(G)  
FP-602F(R) FP-602F(G)

- α (Alpha) Beryllium copper and phosphor bronze Conductor
- Copper Alloy end housing
- PVDF Fluoropolymer insulation
- Connections: Soldered
- Specified for cable diameters up to 12mm



## High Performance XLR Connectors



Rhodium-Plated 24k Gold-Plated  
FP-705M(R) FP-705M(G)  
FP-706F(R) FP-706F(G)

- High performance 4 pin XLR connectors
- Main conductor: 24k Gold-plated α (Alpha) Copper alloy conductor
- Insulation with PBT and fiberglass Resin
- Housing: Nonmagnetic Zinc/Al alloy and Copper alloy (End shell)
- Connections: Soldered
- Specified for cable diameters up to 9mm

24k Gold-Plated  
FP-701M(G)  
FP-702F(G)

- α (Alpha) Copper Alloy center pin
- Copper Alloy end housing
- PBT/fiberglass insulation
- Connections: Soldered
- Specified for cable diameters up to 9mm

- Dimensions:
  - FP-701M: 21.3mm ± 0.1mm diameter x 63.2mm ± 0.1mm overall length
  - FP-702F: 19.5mm ± 0.1mm diameter x 64.2mm ± 0.1mm overall length

## High Performance Audio Spade Terminals



FP-201(R) Rhodium-Plated  
FP-201(G) 24k Gold-Plated

- α (Alpha) Pure copper Conductors
- Connections: Screw down or soldered
- Specified for wire diameters up to 5.0mm
- Dimensions: Space between Conductor: 8.0mm 12.9mm ± 0.1mm (W) x 40mm ± 0.1mm overall length



Rhodium-Plated  
Spade Terminal 10pcs/set

FP-209-10(R)

24k Gold-Plated  
Spade Terminal 20pcs/set

FP-209-10(G)

- α (Alpha) non-magnetic pure copper (t:1.0mm)
- Dimensions: Spade Size: Outside 8mm Inside 4.3 mm Overall length: 25 mm.
- Maximum wire gauge : 8 AWG
- Rhodium-Plated version by request
- Perfect for use with large gauge wiring of Furutech wall receptacles GTX and FPX receptacles and Furutech AC connectors.



The FT-211 features an α (Alpha) pure-copper conductor yielding minimal impedance. The conductor is housed in an extremely nonresonant POM resin body with a shell crafted of nylon and fiberglass using Furutech's outstanding Piezo Ceramic damping material. It's difficult to find better...



Rhodium Plated 24k Gold-Plated  
FT-211(R) FT-211(G)

- Main conductor: Rhodium or 24k gold-plated α (Alpha) pure copper
- Housing: Black nylon/fiberglass with Piezo Ceramic resin
- Body Insulation: Black POM resin injection
- Termination: Set screw
- Specified for core diameters up to 4.5mm
- Specified for core insulation diameter up to 7.8mm
- End Ring: Stainless steel
- Dimensions: Housing: 18.0 X 16.0 φ x 19.8mm overall height Total overall length: 57.5 mm approx.



FP-203(R) Rhodium-Plated  
FP-203(G) 24k Gold-Plated

- α (Alpha) Pure copper Conductors
- Connections: Press down or soldered
- Specified for wire diameters up to 4mm
- Dimensions: Space between Conductor: 8.2mm 12.9mm ± 0.1mm (W) x 24mm ± 0.1mm overall length

## High End Performance XLR Sockets



The FT-785M / 786F series XLR sockets feature α (Alpha) pure copper conductors for minimal impedance set in a super heat resistant liquid crystal polymer resin and a non-resonant nylon/fiberglass housing that incorporates Furutech's super-effective Piezo Ceramic Damping Material. Unique to these special Furutech XLR sockets are special nonmagnetic stainless steel plates that are incorporated into the piezo compound construction using a special Furutech patent-pending process. Pure Transmission principles at their finest!

Solder XLR Socket  
Rhodium Plated Male socket  
FT-785M(R)

Rhodium Plated Female socket  
FT-786F(R)

- α (Alpha) Pure Copper gold-plated or rhodium-plated main conductor
- Insulation Housing: Matte black finished Nylon/fiberglass with piezo ceramic resin (SUS plated internal parts)
- Pin holder & Conductor Inner insulation: Liquid Crystal Polymer Resin
- Connections: Soldered
- Dimensions:
  - FT-785M— 32.0 X 27.0 x 32.7mm (H) overall height
  - FT-786F— 32.0 X 27.0 x 36.9mm (H) overall height

## High End Performance Phono-DIN Connector series



FP-DIN(L)  
FP-DIN

- Rhodium-plated α (Alpha) Phosphor bronze conductor
- Fluoropolymer Insulated Body
- Nonmagnetic stainless steel Housing
- Conductor wire fixed by soldering.
- Specified for cable diameters max. 10.0mm



6.3mm Mono Connector  
FP-Mono-63L(G)  
FP-Mono-63(G)

- Main conductor: One-piece Gold-plated α (Alpha) Copper Alloy main conductor.
- Ground conductor: Gold-plated α (Alpha) Copper Alloy conductor.
- Insulation: PBT. Housing: stainless.
- Rear cover: Nylon (FP-Mono-63L only)
- Cable Clamp: Copper Alloy
- Specified for core insulation diameters up to 7.5mm.
- Connections: Soldered.

## High Performance Phone Jacks



24k Gold-Plated(Mono)  
FP-703(G)  
24k Gold-Plated(Stereo)  
FP-704(G)

- α (Alpha) Copper Alloy center pin
- Copper Alloy end housing with PBT / fiberglass insulation
- Specified for cable diameters up to 8mm
- Connections: Soldered
- Zn-Mg Alloy Casting body housing



# Furutech High End Performance Speaker Binding Posts



## Rhodium-Plated FT-865(R)

Housing: Eutectic copper alloy

## Rhodium-Plated FT-866(R)

Housing: Carbon fiber and nonmagnetic stainless

## Rhodium-Plated FT-867(R)

Housing: Nylon and fiberglass



## FT-809(R) Rhodium-Plated (2 Pcs/Set) VGP 2011

## FT-809(G) 24k Gold-Plated (2 Pcs/Set)

- US Patent No.: 8,241,071
- Patented Torque Guard construction
- Main conductor: Rhodium or 24k Gold-Plated  $\alpha$  (Alpha) Pure Copper conductor
- Housing: Nylon/fiberglass with piezo ceramic and carbon damping material
- Nylon (red/white) and Polycarbonate (clear) insulation
- Connections: Solder or Crimp termination
- Specified for core diameters up to 4.5mm
- Dimensions:
  - Housing unit:  $\varnothing 25.0 \times 30. \text{mm}$  (L)  $\times 38.9 \text{mm}$  overall height
  - Insulation: Polycarbonate (Clear)  $19.3 \varnothing \times 7.3 \text{mm}$  (H)
  - Total overall length: 74.6 mm approx.



### Improved Strengthened Models (US Patented No.: 8,884,162 B2)

### Low-Mass, One-Piece Wire-Wound $\alpha$ (Alpha)-OCC Speaker Binding Posts

Introducing Furutech's revolutionary, Patented FT-860 Series One-Piece Wire-Wound Binding Posts are ideal for speaker builders, manufacturers and do-it-yourselfers looking for low-mass, quality engineered and superb-sounding terminals.

- Patented One piece wound-wire construction
- Main conductor:
  - Rhodium  $\alpha$  (Alpha)-OCC wound-wire conductor
- Low mass POM plastic injected terminal pole
- Nylon (red/white) and Polycarbonate insulation
- Connections: Disconnect connector termination
- Specified for core diameters up to 4.5mm



## FT-818(R) Rhodium-Plated (2 Pcs/Set) VGP 2011

- US Patent No.: 8,241,071
- Patented Torque Guard construction
- Main conductor: Rhodium  $\alpha$  (Alpha) Pure Copper conductor
- Housing: Carbon fiber, nonmagnetic stainless, eutectic copper alloy
- Polycarbonate (red/black) and Polycarbonate (clear) insulation
- Connections: Soldered or set-screw
- Specified for core diameters up to 4.5mm
- Dimensions:
  - Housing:  $25.0 \varnothing \times 30.2 \text{mm}$  (L)  $\times 37.4 \text{mm}$  overall height
  - Insulation: Polycarbonate (Clear)  $19.3 \varnothing \times 7.3 \text{mm}$  (H),
  - Total overall length: 74.6mm approx

## High Performance Speaker Binding Posts

### FP-803(R) Rhodium-Plated (2 Pcs/Set)

### FP-803(G) 24k Gold-Plated (2 Pcs/Set)

- Main conductor: 24k gold-plated  $\alpha$  (Alpha) Phosphor bronze conductor
- Housing: Matte black finished eutectic copper alloy
- Nylon (red/ black) and Polycarbonate (clear) insulation
- Connections: Soldered or set-screw
- Specified for core diameters up to 4.5mm
- Dimensions: Housing:  $15.5 \varnothing \times 21.3 \text{mm}$  (H) overall height  
Insulation: Polycarbonate (Clear)  $19.1 \varnothing \pm 0.2 \text{mm} \times 7.2 \text{mm}$  (H),  
Total overall length: 54.5 mm approx.

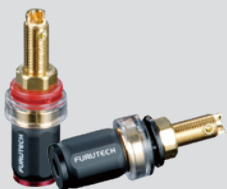

## FT-816(R) Rhodium-Plated (2 Pcs/Set)

- Main conductor:
  - Rhodium  $\alpha$  (Alpha) Pure Copper conductor
- Housing: Carbon fiber, nonmagnetic stainless, eutectic copper alloy
- Connections: Soldered or set-screw
- Specified for core diameters up to 4.5mm
- Dimensions:
  - Housing:  $18.8 \varnothing \times 22.5 \text{mm}$  (H)  $\times 37.4 \text{mm}$  overall height
  - Insulation: Polycarbonate (Clear)  $19.3 \varnothing \times 7.2 \text{mm}$  (H),
  - Total overall length: 59.6mm approx.

## High End Performance RCA sockets

The FT-909 & FT-903 series RCA sockets feature an  $\alpha$  (Alpha) pure copper conductor for minimal impedance set in a super heat resistant Liquid Crystal Polymer Resin housing. The superior compound damping material (LCP) is also incorporated into the chassis nut to ensure there is no resonance. The construction of the FT-909 & FT-903 is patent pending and their design is unique to Furutech!



### FT-903(R) Rhodium-Plated FT-903(G) 24k Gold-Plated

### FT-909(R) Rhodium-Plated FT-909(G) 24k Gold-Plated

- Main conductor: 24k gold-plated  $\alpha$  (Alpha) Pure copper conductor
- Insulation Body: Liquid Crystal Polymer Resin.
- Color ring: Nylon resin (red/white)
- Chassis fixed nut: Plated Lead Free Copper alloy
- Connections: Soldered \*FT-909 Specified for PCB
- FT-909 Dimensions:  $20.2 \times 16.0 \times 36.5 \text{mm}$  (L) overall length approx.
- FT-903 Dimensions:  $16.0 \varnothing \times 40.0 \text{mm}$  (L) overall length approx.
- Rhodium plated version by request

FT-909

### FP-900(G) 24k Gold-Plated

- Central and Earth conductor-  $\alpha$  (Alpha) Copper Alloy Conductor
- Non-magnetic direct 24k Gold-Plated Conductor
- Copper Alloy Housing and Nut cap (24k Gold-Plated )
- Nylon (red, white) Mounting Insulation set and PETF Fluoropolymer (white) Inner insulation.
- Connections: Soldered



## FP-908(R) Rhodium-Plated

## FP-908(G) Gold-Plated

- Rhodium-plated or Gold-plated  $\alpha$  (Alpha) Pure Copper center conductor
- Central Insulation & Outer Insulation Ring: Nylon + Fiberglass (Red, White)
- Conductor fixed by soldering. Specified for PCB
- $\alpha$  (Alpha) copper alloy silver color ring nut
- Dimensions:  $17.0 \text{mm}$  diameter  $\times 21.1 \text{mm}$  (H)  $\times 34.5 \text{mm}$  overall length



## FP-901(R) Rhodium-Plated (2 Pcs/Set)

- Central and Earth conductor-  $\alpha$  (Alpha) Copper Alloy Conductor
- Non-magnetic direct 24k Gold-Plated Conductor
- Copper Alloy Housing and Nut cap (24k Gold-Plated )
- Nylon (red, white) Mounting Insulation set and PETF Fluoropolymer (white) Inner insulation.
- Connections: Soldered

## High Performance Disconnect Terminals

World's First Fully Insulated Pure Copper Female Disconnect Terminal



## FT-210(G) Gold-Plated (10 pcs/set) VGP 2014 SUMMER

- The Furutech FT-210 Fully Insulated Female Disconnect Terminal using 24k Gold-plated  $\alpha$  (Alpha) pure copper conductor.
- Insulation Tube: RoHS Compliant PVC (Yellow)
- Suitable TAB Size:  $0.250 \times 0.032 \text{ " / } 6.35 \times 0.8 \text{ mm}$ .
- Suitable Wire Size: FT-210—5.5 sq. mm max. (12-10 AWG)

## High Performance Crimp Sleeves

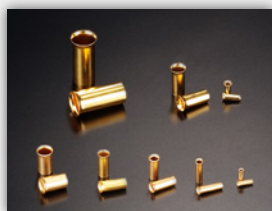

## GS Series

- 24k Gold-plated non-magnetic  $\alpha$  - Conductor
- Material: Pure Copper tube
- Gauges: 2, 4, 8, 10, 12, 14, 20AWG
- GS-11P (I.D. : 1.1mm X Overall length: 6mm) for 20 AWG
- GS-21P (I.D. : 2.1mm X Overall length: 10mm) for 14 AWG
- GS-28P (I.D. : 2.8mm X Overall length: 10mm) for 12 AWG
- GS-35P (I.D. : 3.5mm X Overall length: 10mm) for 10 AWG
- GS-46P (I.D. : 4.6mm X Overall length: 10mm) for 8 AWG
- GS-83P (I.D. : 8.3mm X Overall length: 20mm) for 4 AWG

## High Performance Solder



## S-070-10

- Construction : 96% Sn + 4% Ag. ( Lead Free )
- Rosin Type : Ersin 362Flux : 5 core
- Flux Temp. : Around 380-450°C
- Diameter : 0.7 mm
- Package : 10M (32.8ft) / Roll

## High End Performance SCHUKO Wall Sockets

Another world-class high-performance product from Furutech is our European Schuko-type wall socket. It's manufactured to extremely high standards and is unlike anything else found in the European market. It's sure to be a hit with those looking for the best there is.



### 24k Gold-Plated FP-SWS(G)

Non-magnetic conductors with ABS front plate

- $\alpha$  (Alpha) Pure copper Conductor (t : 0.5mm)
- Material: Nylon/fiberglass body and Poly carbonate cover; Bracket with a 1.0mm thick Zinc/steel brace plate with Zn-Al Alloy Cast Front Plate.

### Rhodium-Plated FT-SWS NCF(R)

Non-magnetic conductors with a Carbon fiber finished face plate

- Specified for wire diameters of 2.5mm (set screw)
- Dimensions: 95.0mm (L) x 95.0mm (W) x 45.9mm(H)
- Rating: 16A 250V A.C.



## High Performance Duplex SCHUKO Wall Sockets



### 24k Gold-Plated FP-SWS-D(G)

Non-magnetic conductors with ABS front plate

- $\alpha$  (Alpha) Pure copper main Conductor (t : 0.5mm)
- Material: Nylon/fiberglass body and Poly carbonate cover; Bracket with a 1.0mm thick Zinc/steel brace plate, ABS Front Plate.
- Specified for wire diameters of 2.8mm or 5.5 Sq.mm/10AWG Max.

### Rhodium-Plated FT-SWS-D NCF(R)

Non-magnetic conductors and NCF (Nano Crystal2 Formula) damping material. Finished with a carbon fiber face plate.

- (set screw)
- Dimensions: 152.0mm (L) x 81.0mm (W) x 48.0mm(H)
- Rating: 16A 250V A.C.



## High Performance BSI 1363 Single and Duplex Wall Sockets



### FP-1363-S(G) FP-1363-S NCF(R) FP-1363-D(G) FP-1363-D NCF(R)

- The world's only true audio grade BSI 1363 Wall socket
- $\alpha$  (Alpha) Pure copper main Conductor (t : 1.2 mm)
- Cover material: ABS front plate and Polycarbonate cover
- Chassis material: Nylon/fiberglass body with 1.0mm thick copper alloy chassis plate
- Specified for wire diameters of 2.8mm or 5.5 Sq.mm/10AWG Max. (set screw)

- Dimensions:  
FP-1363-S---86.0mm (L) x 86.0mm (W) x 23.0mm(H)  
FP-1363-D---152.0mm (L) x 86.0mm (W) x 23.0mm(H)
- Rating: 13A 250V A.C.



## High End Performance SCHUKO Distributor Sockets

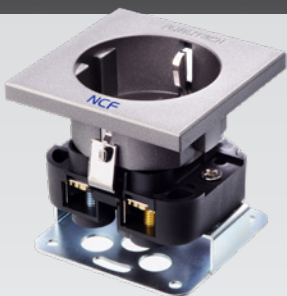

### Rhodium-Plated FT-SDS NCF(R) Non-magnetic conductors

### Rhodium-Plated FT-SDS(R) Non-magnetic conductors

### 24k Gold-Plated FT-SDS(G) Non-magnetic conductors

- $\alpha$  (Alpha) Pure copper Conductor (t : 0.5mm)
- Material: Nylon/fiberglass body and Poly carbonate cover; Base Bracket with a 1.0mm thick Zinc/steel brace plate
- Specified for wire diameters of 2.5mm (set screw)
- Dimensions: 54.7mm (L) x 54.7mm (W) x 52.5mm(H)
- Rating: 16A 250V A.C.

## High Performance SCHUKO Sockets



### Rhodium-Plated FI-E30 NCF(R)

- $\alpha$  (Alpha) Pure Copper Conductor

### 24k Gold-Plated FI-E30(G)

- $\alpha$  (Alpha) Copper Alloy Conductor
- Type: 2-Pole + Earth • Rating: 16A/250V
- Specifications: Accommodates wire diameters to 2.5mm max. (12 AWG)
- Dimensions: 50.6 (L) x 50.6 (W) x 36mm (H)



# High End Performance SCHUKO Connectors

The finest schuko connectors available, electrically and mechanically damped through "NCF" (FI-E50 NCF) and piezoelectric effect (FI-E50R) and Furutech's Floating Field damper function



## SCHUKO Power Connector FI-E50(R)



- α (Alpha) pure-copper rhodium-plated conductors
- Piezo Ceramic series connectors incorporate ceramic nano-sized particles, carbon powder, nylon and fiberglass
- Floating Field Damper function (US Patent No.: 6,669,491/European Patent (EP1445837))
- Specified for cable diameters from 6mm to 20mm
- Dimensions: Body length 56.6mm x 40.5mm diameter x 93mm overall length
- Patented metal cable clamp improves grip and reduces mechanically and electrically induced distortion plus patent-pending specially engineered pressure plate (US Patent No.: 7,976,320)

## Top-Tier SCHUKO Power Connector FI-E50 NCF(R)



NEW

## 24K GOLD-Plated FI-E46 NCF(G)

- α (Alpha) Pure-Copper Gold-plated Conductor
- Floating Field Damper System (US Patent No.: 6,669,491/ European: EP1445837)
- Nylon/fiberglass body with a special anti-resonance nano-sized crystalline, piezo ceramic particles and carbon damping material
- Aluminum (6061 T6) housing brushed and anodized. The best of damping and insulation materials improve frequency extension and tonal balance.
- Specified for cable diameters from 6mm to 20mm

## Rhodium-Plated FI-E38(R)



- α (Alpha) Pure copper Conductors machined from solid pieces of the finest pure copper.
- Floating Field Damper function (US Patent No.: 6,669,491/European Patent (EP1445837))
- Specifications: Accommodates cable diameters from 6mm to 17.0mm
- Dimensions: Body length 56.6mm x 39.6mm diameter x 88.7mm overall length
- Rated: 16A/250V

## 24K GOLD-Plated FI-E38(G)



## Rhodium-Plated FI-E48 NCF(R)

- α (Alpha) Pure-Copper Rhodium-plated or Silver-plated Conductors
- Floating Field Damper (US Patent No.: 6,669,491/European: EP1445837)
- Nylon/fiberglass body with a special anti-resonance nano-sized crystalline, piezo ceramic particles and carbon damping material
- Beautiful polish finished Nonmagnetic SUS303 housing. The best of damping and insulation materials improve frequency extension and tonal balance.
- Specified for cable diameters from 6mm to 20mm

## Silver-Plated FI-E48 NCF(Ag)

# High Performance SCHUKO Connectors

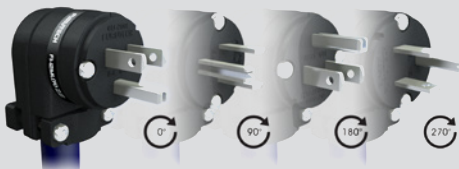

## Rhodium-Plated FI-E12L(R)

Angled Schuko Connector

- Rhodium-plated α (Alpha) pure-copper conductors
- Floating Field Damper System (US Patent No.: 6,669,491/European Patent (EP1445837))
- Nylon/fiberglass body incorporating carbon particles that absorb vibration and resonance
- Specified for cable diameters from 6.6mm to 18.0mm
- Dimensions- 84.0mm Overall Length X 42.2mm X 55.0mm Approx.
- Metal cable clamp improves grip and reduces mechanically and electrically induced distortion
- 4 angle settings • Rating: FI-E12L(R)--16A 250V



## Rhodium-Plated FI-E11-N1(R)

- α (Alpha) Phosphor Bronze Conductor
- Features improved plating and new metal cable clamp for resonance damping and firm grip
- Materials: Front body Nylon/fiberglass • Shell polycarbonate
- Specifications: Accommodates cable diameters from 6.6mm to 16.0mm (With a longer screw up to 20mm)
- Dimensions: Body length 56.2mm x 39.3mm diameter x 89.3mm overall length
- Wire accommodation: Max. 5.5 square mm Max. AWG 10
- Rated: 16A/250V

## 24K GOLD-Plated FI-E11-N1(G)

## NON-Plated FI-E11(Cu)

- α (Alpha) Phosphor Bronze Conductor for FI-E11(G)
- Specifications: Accommodates cable diameters from 6.6mm to 16.0mm (With a longer screw up to 20mm)
- Dimensions: Body length 56.2mm x 39.3mm diameter x 89.3mm overall length
- Wire accommodation: Max. 5.5 square mm Max. AWG 10
- Rated: 16A/250V



# High End Performance UK Mains Connectors



## Rhodium-Plated FI-UK NCF(R)



NEW

## Rhodium-Plated FI-UK(R)

## 24k Gold-Plated FI-UK-N1(G)

Right-angle version

## 24k Gold-Plated FI-UK(G)

## Non plated FI-UK-N1(Cu)

Right-angle version



- α (Alpha) Copper Alloy Conductor
- Material: Fire proof ABS body/housing
- Specifications: Accommodates cable diameters of 4.0mm to 20.0mm (Right-angle version: 4.0mm to 19.0mm)
- Wire accommodation: Max. 5.5 square mm Max. AWG 10
- Dimensions:  
Body 50.4mm (W) x 50.2mm (L) x 55.8mm (H) / 50.2mm dia. x 89.5mm overall length (Straight version)  
Body 50.4mm (W) x 50.2mm (L) x 55.8mm (H) / 79.5mm (H) x 64.0mm overall length (Right-angle version)
- Rated: 13A Fused/250V

# High End Performance AUS/NZ Connectors

## Rhodium-Plated FI-AU-N1(R)

## 24k Gold-Plated FI-AU-N1(G)

- Approvals : NSW 26696 (Australia)
- α (Alpha) Pure copper Conductor
- Features improved plating and new metal cable clamp for resonance damping and firm grip
- Earth (Ground) Jumper System. (US Patent No.: 6,669,491 / European Patent (EP1445837))
- Material: Nylon/fiberglass front body • Polycarbonate shell
- Specifications: Accommodates cable diameters of 6.6mm to 20.0mm
- Wire accommodation: Max. 5.5 square mm Max. AWG 10
- Dimensions: Body length 40.2mm x 44.5mm diameter x 80mm overall length
- Rated: 10A/250V

# Bulk Cables

## Power Cables

### Nano-Ag-Au

The Furutech Nano-Ag-Au power cord uses one of the finest conductors our engineers have designed: the Nano-Ag-Au, featuring our new, finely-tuned gold and silver Nano Liquid. Nano Liquid is a highly effective transmission enhancer, carefully designed to further heighten performance. The molecules in Nano Liquid are so small (approximately 8 nanometers) that they finely coat the conductors and smooth out any and all microscopic surface irregularities that can affect signal transfer and impedance. That means, quite simply, that there is a greater contact area for the conductor.

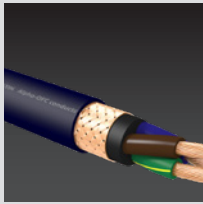

#### FP-S032N 20m/65.6ft/Reel

##### Cable Specifications:

- Alpha Nano-Au-Ag conductor : 45 strands -0.32mm diameter, 12AWG (3.62sq. mm)
- Insulation: Special grade Flexible PVC (Brown, Light Blue, Green/Yellow) diameter 5.0mm
- Inner Sheath: Audio grade flexible PVC (Black) Incorporating damping carbon particles, diameter:12.0mm
- Shield: 0.12mm braided  $\alpha$  (Alpha)  $\mu$ -OFC conductor
- Outer Sheath: Flexible PVC (Dark Blue) diameter 16.0mm

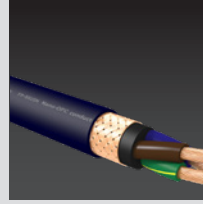

#### FP-S022N 30m/98.4ft/Reel

##### Cable Specifications:

- $\alpha$  (Alpha) Nano-Au-Ag Conductor : 37 strands -0.26mm diameter, 14AWG (2.0sq. mm)
- Insulation: Special grade Flexible PVC (Brown, Light Blue, Green/Yellow) diameter 3.5mm
- Inner Sheath: Audio grade flexible PVC (Black) Incorporating damping carbon particles, diameter:9.3mm
- Shield: 0.12mm braided  $\alpha$  (Alpha)  $\mu$ -OFC conductor
- Outer Sheath: Flexible PVC (Dark Green) diameter 12.9mm

### Alpha PC Triple C

The precision of a sword

The Samurai knew a thing or two about precision engineering: who could argue with the razor-sharp technology of the katana, the Samurai sword? Key to its craftsmanship was a forging process involving repeated rounds of metal folding. Furutech's Alpha PC-Triple C conductor mirrors that technique, using an ingenious proprietary forging process in which variable high pressures are applied to high-purity oxygen-free copper, essentially folding the metal tens of thousands of times. The copper's crystal grain boundaries are thus transformed from a vertical direction into a longitudinal orientation, allowing the electrical signal to flow considerably more smoothly along the completed cable. The copper's crystals become vastly more uniform and well-connected both physically and electrically, creating a much more highly conductive cable.

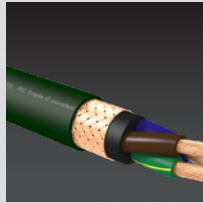

#### FP-TCS31 20m/65.6ft/Reel

##### Cable Specifications:

- Alpha PC Triple C conductor: 45 strands -0.32mm diameter, 12AWG (3.62sq. mm)
- Insulation: Special grade Flexible PVC (Brown, Light Blue, Green/Yellow) diameter 5.0mm
- Inner Sheath: Audio grade flexible PVC (Black) Incorporating damping carbon particles, diameter:12.0mm
- Shield: 0.12mm braided  $\alpha$  (Alpha)  $\mu$ -OFC conductor
- Outer Sheath: Flexible PVC (Dark Green) diameter 16.0mm

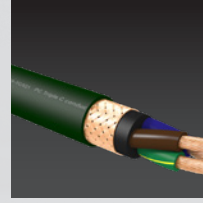

#### FP-TCS21 30m/98.4ft/Reel

##### Cable Specifications:

- Alpha PC Triple C conductor: 80 strands -0.18mm diameter, 14AWG (2.0sq. mm)
- Insulation: Audio grade flexible PVC (Black) Incorporating damping carbon particles, diameter:9.2mm
- Inner Sheath: Special grade Flexible PVC (Black) diameter 9.2mm
- Shield: 0.12mm braided  $\alpha$  (Alpha)  $\mu$ -OFC conductor
- Outer Sheath: Flexible PVC (Dark Green) diameter 12.8mm

### Alpha-OFC



#### FP-3TS762 40m/131ft/Reel

##### Cable Specifications:

- $\alpha$  (Alpha)  $\mu$ -OFC conductor : 7 bundles 35 strands • 0.16mm diameter 10AWG (5.0sq.mm)
- Insulation: Polyethylene (Red/Natural/Yellow) 5.2mm diameter
- Inner Sheath: Audio grade flexible PVC (Black) incorporating carbon damping particles, 12.0mm diameter
- Shield: 9 x 24 strands of 0.12mm stranded-braid  $\alpha$  (Alpha) conductor
- Sheath: Flexible PVC (Dark Blue) approx. 15.5mm diameter.

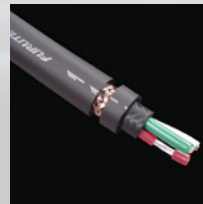

#### FP-314Ag 50m/164ft/Reel

##### Cable Specifications:

- $\alpha$  (Alpha)  $\mu$ -OFC conductor: 2 cores of silver-plated 37 strands -0.25mm diameter and 1 core of 37 strands -0.25mm diameter, 14AWG (1.82sq. mm)
- Insulation: Polyethylene (Red/White /Green) 3.4mm diameter
- Inner Sheath: Audio grade flexible PVC (Black) incorporating carbon damping particles, 9.3mm diameter
- Shield: 9 x 24 strands of 0.12mm braided  $\alpha$  (Alpha) conductor
- Sheath: Flexible PVC (Brown) approx. 12.9mm diameter.

### Alpha-OCC

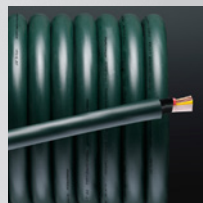

#### FP-Alpha 3 40m/131ft/Reel

##### Cable Specifications:

- $\alpha$  (Alpha)-OCC conductor: 49 strands -0.32mm diameter, 11AWG (3.94sq. mm)
- Insulation: Polyethylene (Red/Natural/Yellow) 5.0mm diameter
- Inner Sheath: Audio grade flexible PVC (Black) incorporating carbon damping particles, 12mm diameter
- Outer Sheath: Flexible PVC (Dark Blue) 15mm diameter approx.

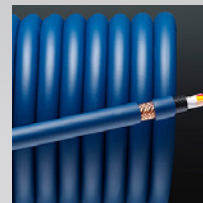

#### FP-3TS20 50m/164ft/Reel

##### Cable Specifications:

- $\alpha$  (Alpha)-OCC conductor: 56 inner and 29 outer strands -0.18mm diameter, 14AWG (2.16sq. mm)
- Insulation: Polyethylene (Red/Natural/Yellow) 3.53mm diameter
- Inner Sheath: Audio grade flexible PVC (Black) incorporating damping carbon particles, 9.6 mm diameter
- Shield: 9 x 24 strands of 0.12mm stranded-braid  $\alpha$ (Alpha) conductor
- Sheath: Flexible PVC (Dark Blue) 14.3 diameter

### Interconnect Coaxial Cable

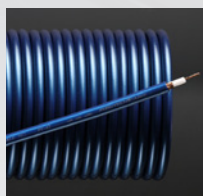

#### FC-62 100m/328ft/Reel

##### Cable Specifications:

- $\alpha$  (Alpha)  $\mu$ -OFC conductor: 19 strands -0.12mm diameter,  $\approx$  24AWG (0.22sq. mm)
- Insulation: High density P.E. plus Air foam P.E. 3.40 mm diameter
- Shield-1: PET/Al Tape wrap
- Shield-2: 0.12mm braided  $\alpha$  (Alpha) Conductor
- Sheath: Flexible PVC approx. 6.3mm diameter
- Package: 100m/Reel

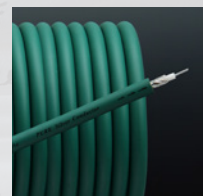

Pure Silver Wire with Fluoropolymer Insulation

#### FX- $\alpha$ Ag 50m/164ft/Reel

##### Cable Specifications:

- $\alpha$  (Alpha) Pure Silver conductor: 7 strands -0.18mm,  $\approx$  25AWG (0.178sq. mm)
- Insulation: Fluoropolymer plus air-foam polyethylene 3mm diameter
- Shield-1: PET/Al tape wrap
- Shield-2: 0.10mm  $\alpha$  (Alpha)  $\mu$ -OFC Conductor wire braid
- Sheath: Flexible PVC (Green) approx. 8.0mm diameter
- Package: 50m/Reel

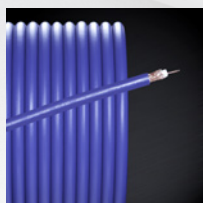

#### FC- $\alpha$ 12 50m/164ft/Reel

##### Cable Specifications:

- $\alpha$  (Alpha) OCC Conductor: 29 strands 0.18mm diameter, 19AWG (0.74sq. mm)
- Insulation-1 : Audio grade P.E. (Transparent)
- Insulation-2: Audio grade High Density Polyethylene Foam
- Shield: 0.12mm braided  $\alpha$  (Alpha) OCC conductor
- Barrier lay: Cotton paper tape wrap
- Sheath: Flexible PVC (Dark Purple Blue) approx. 8.0mm diameter
- Package: 50m/Reel





## Speaker Cables



100m/328ft/Reel

### FS-301

#### Cable Specifications:

- $\alpha$  (Alpha)  $\mu$ -OFC conductor: 7 bundles 34 strands -0.1mm diameter,  $\approx$  14AWG (1.87sq. mm)
- Insulation: Polyethylene (Red/White) 3mm diameter
- Sheath: Flexible PVC (Pearl White) approx. 7.5mm diameter
- Package: 100m/Reel



100m/328ft/Reel

### FS-303

#### Cable Specifications:

- $\alpha$  (Alpha)  $\mu$ -OFC conductor: 7 bundles 28 strands -0.1mm diameter,  $\approx$  15AWG (1.54sq. mm)
- Sheath: Flexible PVC (Pearl White) 4 x 8.4mm overall size
- Package: 10m/20m/30m per blister pack, 100m/Reel



50m/164ft/Reel

### FS-502

#### Cable Specifications:

- $\alpha$  (Alpha)  $\mu$ -OFC conductor: 7 bundles 36 strands -0.1mm diameter, 14AWG (1.98sq. mm)
- Insulation: Polyethylene (Red/White) 3.0mm diameter
- Twisting: Two cores twisted together with cotton yarn
- Shield: PET/Al tape wrap plus 7 strands • 0.2mm  $\alpha$  (Alpha) conductor
- Sheath: Flexible PVC (Pearl Light Blue) approx 8.0mm diameter
- Package: 50m/Reel



50m/164ft/Reel (Solid-Core)

### FS-15S

#### Cable Specifications:

- $\alpha$  (Alpha)  $\mu$ -OFC conductor: solid-core 1.5mm diameter, 15AWG (1.77 sq. mm)
- Insulation-1: Teflon (Clear) 2.2mm diameter
- Insulation: Polyethylene (Red/White) 2.6mm diameter
- Twisting: Two cores twisted together with cotton yarn
- Shield: PET/Al tape wrap plus 7 strands • 0.2mm  $\alpha$  (Alpha)  $\mu$ -OFC Conductor
- Sheath: Flexible PVC (Dark Green) approx. 8.2mm diameter
- Package: 50m/Reel



40m/131ft/Reel

### Alpha-S25

#### Cable Specifications:

- $\alpha$  (Alpha) OCC conductor: 7 bundles 18 strands -0.16mm diameter, 13AWG (2.53 sq. mm)
- Insulation: Special Polyethylene (Red/ White)
- Twisting: 2 Cores with Cotton fillers twisted Together
- Barrier Layer: Paper Tape Wrap
- Jacket: Ultra Flexible Pb free PVC (Dark Blue)
- Max. Conductor Resistance: 0.0078  $\Omega$  / M
- Overall Diameter: 14.5 mm

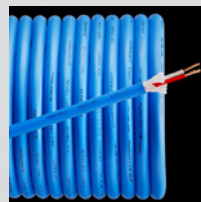

50m/164ft/Reel

### Alpha-S14

#### Cable Specifications:

- $\alpha$  (Alpha) OCC conductor: 56 strands -0.18mm diameter, 15AWG (1.42 sq. mm)
- Insulation: Special Polyethylene (Red/ White)
- Twisting: 2 Cores with Cotton fillers twisted Together
- Barrier Layer: Paper Tape Wrap
- Jacket: Ultra Flexible Pb free PVC (Light Blue)
- Max. Conductor Resistance: 0.0135  $\Omega$  / M
- Overall Diameter: 8.9 mm

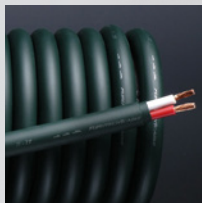

50m/164ft/Reel

### $\mu$ -2T

#### Cable Specifications:

- $\alpha$  (Alpha)  $\mu$ -OFC conductor: 6 bundles 20 strands -0.18mm diameter, 13AWG (3.05 sq. mm)
- Insulation: Polyethylene (Red/White) 5.1mm diameter
- Sheath: Flexible PVC (Dark Green) approx. 13.5mm diameter
- Package: 50m/Reel

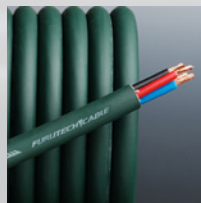

50m/164ft/Reel (Bi-wire)

### $\mu$ - 4.1T

#### Cable Specifications:

- $\alpha$  (Alpha)  $\mu$ -OFC conductor-1: 21 strands -0.15mm plus 6 bundles 46 strands -0.1mm diameter, 13AWG (2.54 sq. mm)
- $\alpha$  (Alpha)  $\mu$ -OFC conductor-2: 7 bundles 5 strands -0.3mm diameter, 13AWG (2.47 sq. mm)
- Insulation-1: Polypropylene (for high frequencies Blue/Black) 3.6mm diameter
- Insulation-2: Polypropylene (for bass frequencies Red/White) 3.6mm diameter
- Sheath: Flexible PVC (Dark Green) approx. 11.0mm diameter
- Package: 50m/Reel

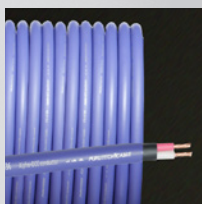

50m/164ft/Reel

### FS- $\alpha$ 36

#### Cable Specifications:

- $\alpha$  (Alpha) OCC conductor: 6 bundles 20 strands -0.18mm diameter,  $\approx$  12AWG (3.05 sq. mm)
- Insulation: Audio grade PE (Red/White) 5.1mm diameter
- Twisting: Two cores twisted together
- Inner sheath: Audio grade flexible PVC (Black) incorporating carbon damping particles
- Sheath: RoHS Compliant Flexible PVC (Purple-blue) approx. 13mm diameter
- Package: 50m/Reel

## Interconnect Balanced Cable

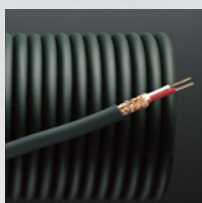

### FA-13S 50m/164ft/Reel (Solid-Core)

#### Cable Specifications:

- $\alpha$  (Alpha)  $\mu$ -OFC conductor: Solid-core 1.3mm diameter, 16AWG (1.33 sq. mm)
- Insulation: Audio grade Polypropylene (Red / White), 2.4mm diameter
- Twisting: Two cores twisted together with cotton yarn
- Shield: 0.12mm braided  $\alpha$  (Alpha) conductor
- Sheath: Flexible PVC (Dark Green) approx 8.0mm diameter
- Package: 50m/Reel

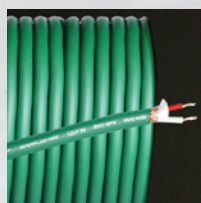

### FA- $\alpha$ S21 50m/164ft/Reel

#### Cable Specifications:

- $\alpha$  (Alpha) OCC conductor: 30 strands -0.18mm diameter, 18AWG (0.76 sq. mm)
- Insulation: Audio grade PP (Red/White) 2.46mm diameter
- Twisting: Two cores twisted together with cotton yarn
- Barrier layer: Stabilizer Paper Tape (Wrap)
- Shield: 0.12mm braided  $\alpha$  (Alpha) conductor
- Sheath: Audio Grade Flexible PVC (Dark Green) approx 8.0mm diameter
- Package: 50m/Reel



### SA-22 50m/164ft/Reel

#### Cable Specifications:

- $\alpha$  (Alpha)  $\mu$ -OFC conductor: 80 strands -0.18mm diameter, 14AWG (2.0 sq. mm)
- Insulation: Special Polyethylene (Red/ White)
- Twisting: 2 Cores with Cotton fillers twisted Together
- Shield: AL/PET tape wrap plus 0.12mm  $\alpha$  (Alpha)  $\mu$ -OFC Conductor wire Braid
- Barrier Layer: Paper Tape Wrap
- Jacket: Ultra Flexible Pb free PVC (Dark Brown)
- Cable Type: Hyper Balanced
- Max. Conductor Resistance: 0.00924  $\Omega$  / M
- Overall Diameter: 9.0 mm



### FA- $\alpha$ S22 50m/164ft/Reel

#### Cable Specifications:

- $\alpha$  (Alpha) OCC conductor: 60 strands -0.18mm diameter,  $\approx$  15AWG (1.52 sq. mm)
- Insulation: Audio grade PP (Red/White) 2.6mm diameter
- Twisting: Two cores twisted together with cotton yarn
- Barrier layer: Stabilizer Paper Tape (Wrap)
- Shield: 0.12mm braided  $\alpha$  (Alpha) conductor
- Inner sheath: Audio grade flexible PVC (Black) incorporating carbon damping particles
- Sheath: Audio Grade Flexible PVC (Purple-Blue) approx 9.0mm diameter





# Furutech designs and builds each and every product using our Pure Transmission Philosophy

- Hyper-pure non-magnetic materials
- Hyper-precision manufacturing techniques
- Special plating techniques

Furutech uses the following conductors treated with the Furutech  $\alpha$  Alpha 2-Stage Super Cryogenic and Demagnetizing Treatment.

PCOCC:  $\alpha$  (Alpha)-OCC

$\mu$ -OFC:  $\alpha$  (Alpha)  $\mu$ -OFC

Pure Copper:  $\alpha$  (Alpha) Pure copper

Phosphor Bronze:  $\alpha$  (Alpha) Phosphor Bronze

Copper Alloy:  $\alpha$  (Alpha) Copper Alloy

Silver:  $\alpha$  (Alpha) Silver

Silver Copper OCC:  $\alpha$  (Alpha) Silver Hybrid OCC

Nano-OFC: Nano-Ag-Au OFC

Nano-OCC: Nano-Ag-Au OCC

PC Triple C: PC Triple C

## AWARDS

Innovations Honoree CES 2011

Best of Innovations CES 2009

Best of Innovations CES 2007

"Golden Ear Award" The Absolute Sound 2011

"Product of the Year Award" The Absolute Sound

"Editors' Choice Award" The Absolute Sound 2020, 2021, 2022, 2023

"Blue Moon Award" 6moons.com

"Best of 2019 Award" Enjoythemusic.com

"Product of the Year" Tone Audio

"Best Product" High Fidelity

"Editor's Choice" HiFi News

Positive Feedback Online Brutus Award Winner

Reviewers Choice Award Soundstage.com

Product of the Year Award High Fidelity Poland

MJ Audio Technology Award Japan

TOP TEST AWARD Sound & Vision Hungary

Top Show Award HDI Show Moscow

ExValue Award Tone Audio

HAUTE FIDELITE France

VISUAL GRAND-PRIX (Japanese Magazine: AV REVIEW)

AUDIO EXCELLENCE AWARD (Japanese Magazine: Audio Accessory)

All Furutech Power Series products are PSE approved

- UL/CUL approved products available
- PCOCC is a registered trademark of Furukawa Electric Co., Ltd.

In keeping with our Pure Transmission Philosophy and to improve on and manufacture more effective products, Furutech reserves the right to change product specifications and materials without prior notice.

**ENCF**<sup>®</sup> NCF is only found in Furutech products and is a registered trademark of Furutech Co., Ltd, Tokyo Japan

## FURUTECH Co., Ltd.

Furutech Bldg., 3-9-1 Togoshi, Shinagawa-Ku Tokyo, 142-0041, Japan

TEL : +81-3-6451-3941 FAX : +81-3-6451-3942

E-mail: [service@furutech.com](mailto:service@furutech.com)

URL: [www.furutech.com](http://www.furutech.com)

 Furutech is pleased to announce that its products conform to the requirements of the RoHS Directive. (FDHE-OV-09-2)

Furutech reserves the right to change product specifications without prior notice.

